

# FICHE TECHNIQUE

## PRESTIO Entretoise

Réf. 2385 – EAN 3443440023852 – GRIS KARAKO – RAL 9006

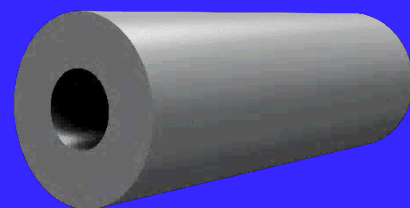

**Qualité professionnelle**

**Solution prête à poser**

**Matériaux : aluminium texturé**

**Pose en applique**

**Utilisation intérieur/extérieur**

**INSTALLATION FACILE, FIABLE ET FAISABLE PAR TOUS**

**Garantie 5 ans**

### Composition pack



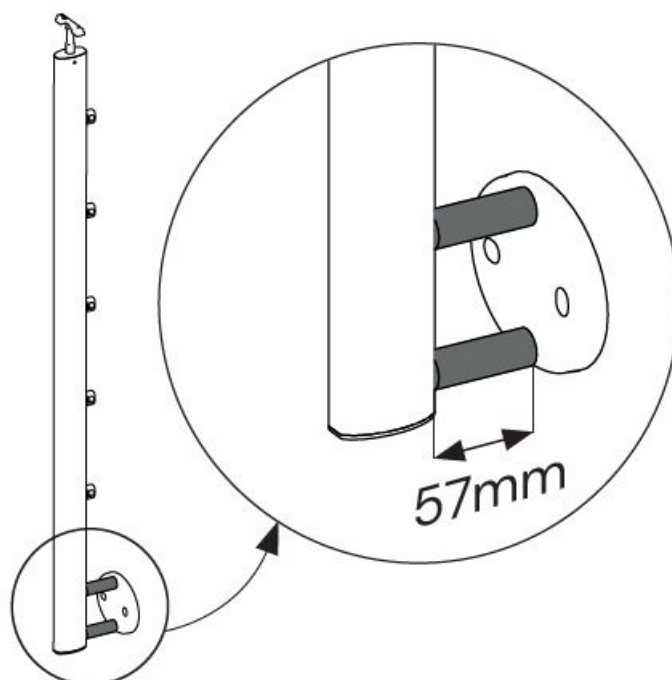

2 entretoises pour applique

2 vis à tête fraisée

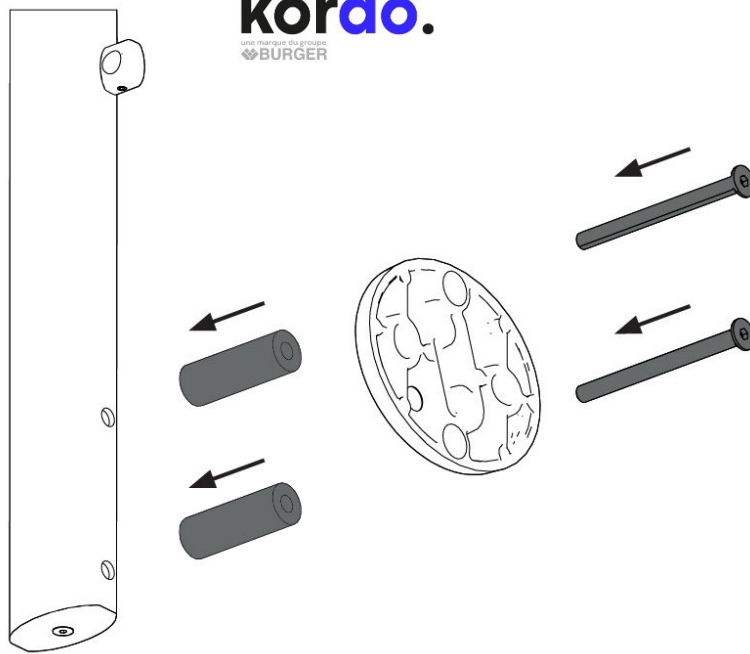
RAL 9006





		Ø 8 x 100	x2	Acier zingué
		Ø 20 x 57	x2	Aluminium texturé

## LOGISTIQUE



### Gencod

3443440023852 – réf 2385

### Livré

Sous blister

### Poids unité de vente

0,280 kg

### Colis

2,40 cm x 18 cm x 15 cm

## INFOS COMPLÉMENTAIRES



### Conditionnement:

Unité de vente : 1 pce