

FICHE TECHNIQUE

PRESTIO Entretoise

Réf. 2395 – EAN 3443440023951 – ANTHRACITE – RAL 7016

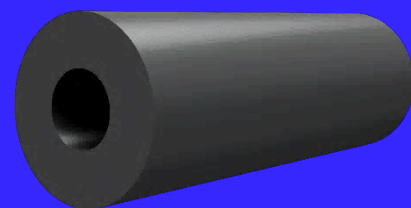

Qualité professionnelle

Solution prête à poser

Matériaux : aluminium texturé

Pose en applique

Utilisation intérieur/extérieur

INSTALLATION FACILE, FIABLE ET FAISABLE PAR TOUS

Garantie 5 ans

Composition pack



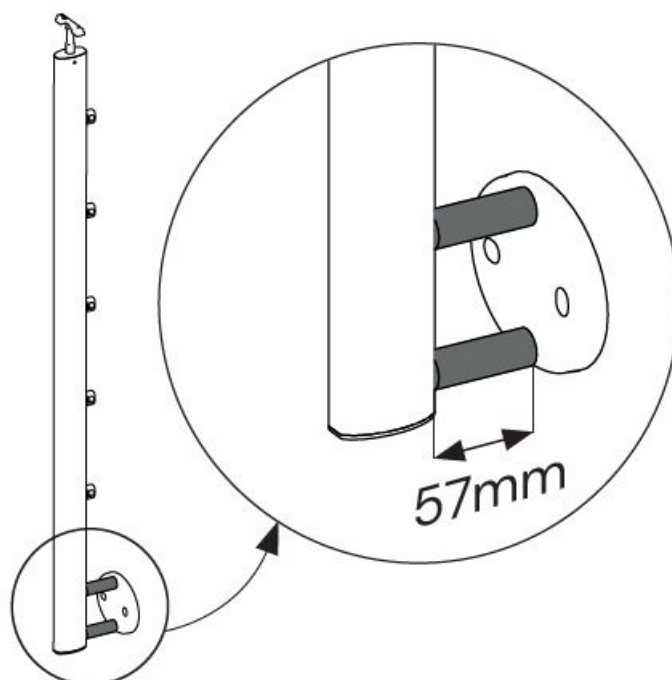

2 entretoises pour applique

2 vis à tête fraisée

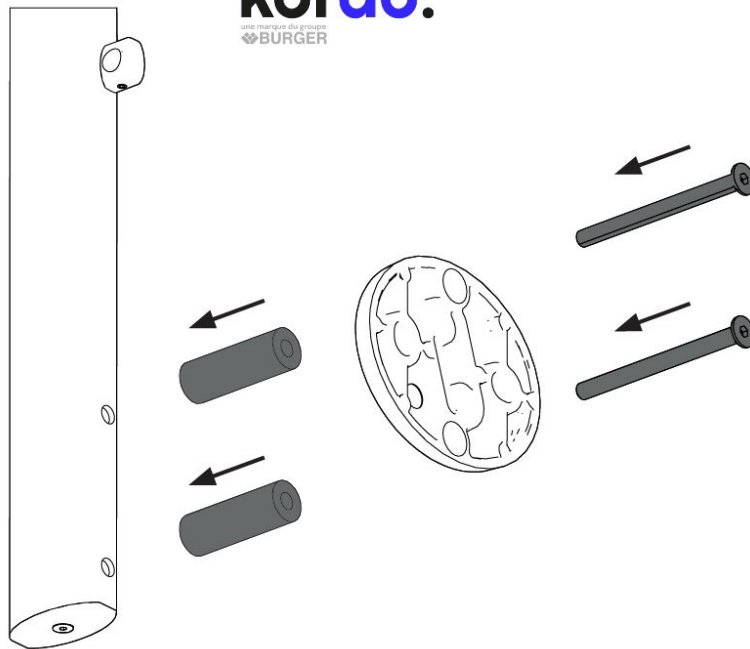
RAL 7016





		Ø 8 x 100	x2	Acier zingué
		Ø 20 x 57	x2	Aluminium texturé

LOGISTIQUE



Gencod

3443440023951 – réf 2395

Livré

Sous blister

Poids unité de vente

0,280 kg

Colis

2,40 cm x 18 cm x 15 cm

INFOS COMPLÉMENTAIRES



Conditionnement:

Unité de vente : 1 pce