

ASSEMBLY NOTICE

Notice de montage
Montage handleiding
Montageanleitung
Manuale d'istruzione
Instrucciones de montaje
Instruções de montagem



Abri Massif 19mm

2,33x2,33m SF/SPV-SPL

ref 52115S160

Made in Belgium

General instructions – Read carefully before you start

Thank you for buying your shed. We would ask that you read these instructions carefully before unpacking the parts.

Storing the packages before assembling the shed

Store the packages in a dry and ventilated place, out of direct sunlight and protected from the weather (packaging not waterproof).

The packages and parts should be laid flat on the ground in order to avoid any deformation.

Assemble the shed as soon as possible after it arrives (the after sales service is available for a maximum of 10 days after the date of purchase).

Safety advice

The wooden parts may cause splinters. Handle the wood carefully, using protective gloves.

Check there are no protruding nails, screws or staples in the assembled pieces.

Always follow the instructions carefully, keeping to the order in which they are to be assembled.

Assembly

The shed must be built in an area sheltered from strong winds.

Do not expose the wooden parts or the roof covering to direct sunlight during assembly.

Start by checking that all parts have been included, using the inventory provided to identify them by shape and length.

Before starting, check that the base on which the shed is to be built is perfectly flat and level.

The with-floor model consists of beams and panels/planks to be assembled on a solid and stable floor surface. Lay down supports (concrete beams or blocks, min 40mm thick) in order to ensure good ventilation.

For the floorless shed models, the concrete slabs should be the same size or larger than the floor. Check that it is square by measuring the diagonals.

All parts are the correct size and do not need to be cut (except some types of crosspieces, glazing stops and the roofing).

Whilst assembling the shed, regularly check that everything is level and square.

For all parts that need to be assembled using screws, it is advisable to pre-drill holes in the first part, otherwise there is a risk that the wood will split when screwing.

Interior reinforcements (for plank-construction sheds)

The reinforcement battens should be placed in the internal corners in order to fix the points to the main body of the shed (one single screw at the ends of the reinforcements). Regularly check these joints, and adjust them according any movement of the wood (dryness, humidity etc.).

For fixed window frames (depending on the model): Before screwing, it is advisable to size the mortises and tenons of the vertical and traverse sections using wood glue (not supplied).

The crosspieces and glazing stops for the doors and win-

dows are obtained by cutting this wood to the correct size.

Fixing the shed

Always fix the shed securely to the ground using all appropriate methods (not supplied).

For the with-floor model: Fix it to the body of the shed, and place weight on it as ballast. Fixings are not supplied.

Roof

Start laying the roof covering at the bottom of the roof, leaving an overhang of 40 mm at the front and back, and then fold it over the edge of the roof.

For black roofing: Leave a 70mm overhang of roofing on the side, then fold it under the roof panel and fix it using large-headed nails (200 mm max).

For green roofing: Leave a 10mm overhand of roofing on the sides, and fix it using large-head nails (200 mm max).

Finish by affixing the edging planks using screws.

Advice

Pine wood is a living material that never stops moving and may be slightly deformed (wood slightly bowed or warped) or have imperfections such as splits, knots and resin pockets.

This is normal and does not affect the lifespan of your shed. Wood putty (not supplied) may be an easy solution.

For interlocking sheds, note that all planks have a good face which should face towards the outside of the shed (the non-visible face may have some planning defects, bark, splits etc.).

Synthetic panes should not be nailed as there is a risk they may split. We recommend fixing them with silicone (not supplied) or pre-drilling the holes before screwing.

Maintenance

It is important to treat the shed using a product for protecting exterior wood surfaces, containing fungicides, insecticides and UV protection. Apply a minimum of 2 coats to the outside and 1 to the inside. Repeat regularly, as required.

After Sales Service

Any missing parts or defects must be declared using the After Sales Service form (available in shops) within 10 days following purchase of the shed, supported by an invoice or till receipt.

Our After Sales Service can repair or replace faulty parts. Any costs for fitting and removal are not included.

Décor et Jardin SA will not be responsible in the event that a client chooses to alter a product without prior permission.

For all After Sales Service requests, please ensure that you adhere strictly to the procedure available in shops (After Sales Service procedure): You need your till receipt or proof of purchase, product reference, and exact reference of the faulty piece.

Conseils généraux préalables à lire attentivement

Nous vous remercions pour l'acquisition de ce chalet, et nous vous invitons à lire attentivement la notice avant de commencer à déballer le colis.

Stockage du colis avant le montage de l'abri

Stockez votre colis dans un endroit sec et ventilé, à l'abri du soleil et des intempéries (emballage non hermétique). Le colis et les pièces doivent être posés à plat sur le sol afin d'éviter les déformations.

Procédez au montage dans un délai minimum après réception du produit (le délai de service après-vente est de 10 jours maximum après la date d'achat).

Consignes de sécurité

Les pièces en bois peuvent présenter un risque d'écharde. Manipulez les bois avec précaution, avec des gants de protection.

Vérifiez qu'aucun clou, vis ou agrafe ne dépasse des pièces assemblées.

Toujours suivre attentivement les instructions et l'ordre de montage de la présente notice.

Opération de montage

Il est indispensable d'installer l'abri dans un endroit protégé des vents violents.

Ne pas exposer les pièces en bois et le revêtement de toiture au soleil durant le montage.

Commencez par trier, identifier et vérifier les pièces par rapport à la nomenclature, en vous référant à leur section et à leur longueur.

Avant de commencer, assurez-vous que la base sur laquelle l'abri sera installé soit parfaitement plane, et de niveau.

L'option plancher est composée de chevrons et de plaques/planches à assembler sur un sol ferme et stable. Mettre des supports (blocs ou poutres béton de 40mm min. d'épaisseur) pour assurer une bonne ventilation.

Pour l'abri sans plancher, la dalle béton doit avoir des dimensions égales ou supérieures aux dimensions du plancher. Vérifiez son équerage en prenant les diagonales.

Les pièces sont toutes aux bonnes dimensions, ne pas les couper (exception faite de certains types de croisillons, de lattes à vitrage, roofing).

Contrôlez régulièrement le niveau et l'équerage de ce que vous montez.

Pour toutes les pièces assemblées par vis, il est conseillé de préforer la première pièce, sinon le bois risque de se fendre lors du serrage.

Renforts intérieurs (si abri massif)

Les lattes de renfort à placer aux angles à l'intérieur servent à solidariser la pointe au corps de l'abri (1 seule vis aux extrémités des renforts). Vérifiez régulièrement ces fixations, et les ajuster en fonction du travail du bois (sècheresse, humidité,...)

Pour les châssis fixes de fenêtre (selon modèle) : avant le vissage, il est conseillé d'encoller les tenons et mortaises des montants et traverses avec de la colle à bois (non fournie).

Les croisillons et lattes à vitrage des portes et fenêtres sont

obtenus en coupant ces bois aux dimensions adéquates.

Fixation de l'abri

Toujours fixer solidement l'abri au sol par tous moyens appropriés (non fournis).

Si option plancher : le fixer au corps de l'abri, et mettre du poids pour le lester. Les moyens de fixation ne sont pas fournis.

Toiture

Commencez la pose du revêtement de toiture par le bas du toit, en laissant dépasser le roofing de 40mm à l'avant et à l'arrière, le rabattre sur le chant du toit.

Si roofing noir : laissez dépasser le roofing de 70mm sur le coté, puis le replier sous la plaque de toit et le fixer à l'aide des clous à tête large (tous les 200mm max.).

Si roofing vert : laissez dépasser le roofing de 10mm sur les cotés et le fixer à l'aide des clous à tête large (tous les 200mm max.).

Finissez par apposer les planches de rive à l'aide de vis.

Remarques

Le bois de sapin est un matériau vivant qui ne cesse de travailler, et peut présenter certaines déformations (bois légèrement voilés ou gondolés), des fentes, des nœuds tombant et des poches de résine.

Ceci est normal, et ne met pas en péril la longévité de votre abri. L'application de pâte à bois (non fournie) peut-être une solution simple.

Pour les abris à emboîtement, veuillez noter que toutes les planches ont toujours une belle face qui doit être positionnée à l'extérieur de l'abri (la face cachée peut présenter certains défauts de rabotage, écorce, fentes, ...)

Les vitres synthétiques ne doivent pas être clouées au risque de les fendre. Nous vous conseillons de les fixer au silicone (non fourni) ou de les forer avant de les visser.

Entretien

Il est impératif de traiter l'abri à l'aide d'un produit de protection pour bois à l'extérieur, contenant des agents fongicides, insecticides et anti-UV. Minimum 2 couches à l'extérieur + 1 couche à l'intérieur.

Renouvelez régulièrement l'opération selon l'usage.

Service après-vente (SAV)

Tout manquement doit être signalé au moyen du formulaire SAV (disponible en magasin) dans les 10 jours suivant l'achat, facture ou ticket de caisse à l'appui.

Notre SAV consiste en la réparation ou au remplacement de la pièce défectueuse. Les éventuels frais de pose et de dépose ne sont pas pris en charge.

Tout client prenant l'initiative d'intervenir sur un produit sans validation préalable par Décor et Jardin SA décharge de ce fait Décor et Jardin SA de toute responsabilité.

Pour toute demande de SAV, veuillez vous conformer strictement à la procédure disponible en magasin (Procédure SAV) : ticket de caisse ou preuve d'achat, référence du produit, référence exacte de la pièce défectueuse.

Algemene richtlijnen. Aandachtig lezen aub.

Eerst en vooral hartelijk dank voor uw aankoop van dit tuinhuis. Wij raden u aan om deze richtlijnen na te lezen vooraleer u de verpakking helemaal openmaakt.

Stockagevoorschriften

Stockeer het verpakte tuinhuis op een droge en geventileerde plaats, beschut tegen zon en neerslag (de verpakking is niet hermetisch). Zorg ook voor een vlakke ondergrond, zodat de onderdelen niet kunnen vervormen. Monteer het tuinhuis zo vlug mogelijk na de levering (Er geldt 10 dagen dienst na verkoop vanaf het moment van de aankoop).

Veiligheidsvoorschriften

De houten onderdelen kunnen splinters bevatten. Draag daarom altijd veiligheidshandschoenen. Verifieer ook steeds of er geen nagels, nieten of vijzen uitsteken. Volg steeds nauwgezet en in de juiste volgorde de montage-instructies.

Montagevoorschriften

Monteer het tuinhuis nooit op een plaats die onderhevig kan zijn aan zeer veel wind. Stel de onderdelen en de dakbedekking tijdens de montage niet bloot aan de felle zon. Begin steeds met de identificatie en de controle van alle onderdelen. Let daarbij op de houtsectie (dikte en breedte) en de lengte. Vooraleer u met de montage begint moet u er zich van verzekeren dat de ondergrond waarop u zal installeren perfect vlak en pas is. De optie 'plankenvloer' bestaat uit onderliggers en platen of planken die op een stabiele en stevige ondergrond dienen geplaatst te worden. Plaats als ondersteuning blokken of balken in beton voor een goede ventilatie. Indien er geen plankenvloer voorzien is, moet de betonvloer perfect dezelfde of een groter oppervlak bestrijken dan de binnenoppervlakte van het tuinhuis. Controleer de haaksheid door middel van de diagonalen. Alle onderdelen hebben reeds de juiste afmetingen en dienen dus niet meer verzaagd te worden (uitgezonderd sommige types kleinhouten voor de ramen, daklatten en roofing). Controleer regelmatig het niveau en de haaksheid van hetgeen u monteert. Het is aangeraden om voor te boren indien u onderdelen aan elkaar moet vijzen (risico op splijten).

Binnenverstevingingen (bij massieve modellen)

De verstevigingslatten die aan de binnenhoeken moeten geplaatst worden, dienen om het topgevel-element aan het wandelement vast te maken. Schroef deze latten enkel aan de twee uiteinden vast ! Controleer deze bevestiging nog een aantal keren na de plaatsing, zodat bij werking van het hout (bij nat of zeer droog weer) nog wat kan aangeschroefd worden. Bij het samenstellen van de raamkaders (afhankelijk van het model) is het aangeraden om de pen en gatverbinding eerst in te lijmen vooraleer ze worden gevezen (lijm niet bijgeleverd). De kleinhouten kruisen en glaslatten voor de ramen en deuren dienen nog op de juiste lengte worden verzaagd.

Verankeren van het tuinhuis

Veranker het tuinhuis met de juiste middelen (bevestigingsmateriaal is niet meegeleverd) aan de ondergrond. Hebt u als optie de plankenvloer meegeleverd gekregen, schroef deze dan ook vast aan de wanden. Plaats onmiddellijk na de plaatsing gewicht op de vloer.

Dakbedekking

Voor de plaatsing van de dakbedekking begint u onderaan. Laat de roofing 40 mm overlappen aan voor- en achterzijde en plooi deze over aan de randen.

Bij zwarte roofing : Laat de roofing aan de zijkanten 70 mm overlappen, plooi deze over naar de onderkant van de dakplaat en maak vast dmv nagels met brede kop (tussenafstand nagels max 20 cm).

Bij groene roofing : Laat de roofing aan de zijkanten 10 mm overlappen en maak vast dmv nagels met brede kop (tussenafstand nagels max 20 cm).

Werk de dakbedekking af door de randplanken erop vast te schroeven.

Opmerkingen

Naaldhout is een levend materiaal dat blijft 'werken' en dus ook bepaalde vervormingen kan vertonen : lichte schooteling, barsten, uitgevallen knopen en harsgangen. Dit is normaal en doet geen afbreuk aan de levensduur van het tuinhuis. Bepaalde van deze fenomenen kan u verhelpen met vloeibare houtpasta (niet meegeleverd). De losse planken van de massieve tuinhuisen hebben een mooie zijde (die naar buiten moet geplaatst worden) en een minder mooie zijde (naar binnen toe te plaatsen) die schaffoutjes, schors of barsten kan vertonen. De kunststof vensters mogen niet genageld worden (risico op barsten). We raden u aan om ze met silicone te bevestigen (niet bijgeleverd) of voor te boren als u ze wil schroeven.

Onderhoud

Het is absoluut noodzakelijk om het tuinhuis te behandelen met een beschermingsproduct voor buitenhout dat ingrediënten bevat die het hout beschermen tegen houtzwammen, insecten en UV. Breng minimum 2 lagen aan langs de buitenkant en minimum 1 laag aan de binnenkant. Herhaal deze behandeling volgens blootstelling en veroudering.

Dienst na Verkoop

Ieder gebrek aan onze producten dient binnen de 10 dagen na de aankoop gemeld te worden dmv het 'Dienst na Verkoop'-formulier, vergezeld van de factuur of het kasticket. Onze Dienst na Verkoop omhelst de herstelling of de vervanging van het gebrekkige onderdeel. De eventuele kosten gekoppeld aan het werk dat deze operatie met zich meebrengt zijn niet gedekt door onze Dienst na Verkoop. Indien zonder voorafgaand akkoord door Décor et Jardin herstellingen of aanpassingen aan het product zijn gebeurd, dan vervalt alle verantwoordelijkheid van Décor et Jardin over de kwaliteit van het product. Indien u op onze Dienst na Verkoop wil beroep doen, houd u dan aan de voorziene procedure via het formulier dat u in het verkooppunt kan aanvragen. Zorg in elk geval ook voor het kasticket, voor het referentienummer van het product en de referentie van het desbetreffende onderdeel.

Allgemeine Ratschläge zu lesen

Wir bedanken uns für Ihr Einkauf, und wir bitten Sie die folgende Montageanleitung zu lesen bevor das Paket ausgepackt wird.

EINLAGERUNG DES PAKETES BEVOR MONTAGE

Das Paket wird in einem trockenen Ort eingelagert. (vor Sonne geschützt und schlechtes Wetters).

Das Paket und die Stücke werden flach auf dem Boden gelegt um alle Verformungen zu vermeiden.

Nach Empfang des Produktes raten wir Ihnen die Montage innerhalb von 10 Tagen zu machen. (Nach dem Einkauf wird eine Frist v. 10 Tagen für evt. Reklamationen gewährt).

SICHERHEITSRATSCHLÄGE

Die Holzstücke können Splitter haben / mit Handschuhen zu behandeln.

Prüfen ob kein Nägel, keine Schraube, keine Klammer übersteht.

Die Vorschriften und die Montageanweisung müssen immer gefolgt werden.

ANBAUANLEITUNG

Es ist notwendig, das Gartenhaus an einem Ort zu stellen, wo es vor starkem Wind geschützt ist.

Während der Montage werden die Holzstücke und die Dachpappe nicht in der Sonne gelegt.

Zuerst die Stücke laut die Montageanleitung sortieren (Lengte und Schnitte)

Vor Montagebeginn, ist zu überprüfen ob die Bodenfläche waagrecht und im Winkel ist.

AUSWAHL :

Fussboden mit Sparren und Platten/Bretter, der auf einem festen Boden zusammengestellt wird. Betonblöcke oder Pflastersteine von mindestens 40mm Dicke zu bauen um die Durchlüftung des Gartenhauses zu gewährleisten.

Ohne Fussboden : der Sockel muss mindestens die selben Massen wie den Fussboden haben.

Bodenfläche und Winkel des Sockels überprüfen.

Die Stücke werden nie geschnitten (ausser Fensterkreuzen, Fensterbearbeitungslatte, Dachpappe)

Regelmässig während der Montage die Winkel kontrollieren.

INNENVERSTÄRKUNGEN (Blokhütte)

Die Verstärkungslatten sind innen in die Ecken des Gartenhauses zu setzen, so werden die zusammengestellten Spitzen und das Gartenhauskorpus solidarisch (nur eine Schraube an Verstärkungsende). Regelmässig prüfen und die Befestigungen im Verhältnis der Holzarbeit anpassen (Trockenheit, Feuchtigkeit ...)

Kunststoffglaslatten und Fenstersprossen für Fenster und Türe auf den richtigen Massen schneiden.

BEFESTIGUNG DES GARTENHAUSES

Das Gartenhaus muss auf dem Boden befestigt werden oder belastet werden (nicht mitgeliefert).

Mit einem Fussboden : er soll an dem Gartenhaus befestigt und belastet werden. Die Befestigungsmöglichkeiten sind nicht mitgeliefert.

BEDACHUNG

Der Belag von unten nach oben legen. Die Dachpappe 40mm vorne und hinten überstehen lassen und auf der Schmalseite der Platte umklappen.

Schwarze Dachpappe : An der Seite 70mm überstehen lassen. Die Dachpappe auf der Schmalseite der Platte umklappen und mit Nägeln mit extra breitem Kopf befestigen. (max. alle 200mm)

Grüne Dachpappe : An der Seite 10mm überstehen lassen und mit Nägeln mit extra breitem Kopf befestigen. (max. alle 200mm)

Die Windbretter werden auf der Dachpappe geschraubt.

BEMERKUNGEN

Das Fichtenholz ist ein lebendes Material, das heisst, das das Holz arbeitet. Einige Verformungen sind immer möglich (Holz leicht verzogen), Spalte, fallende Knoten und Harzsack. Das spielt keine Rolle auf der Qualität des Gartenhauses. Holzschliff kann eine einfache Lösung sein. (nicht miteliefert)

Blokhütten haben immer Bretter mit einer schönen Fläche. Diese Fläche ist auf der äussere Seite des Gartenhaus zu montieren.

(die Innenseite der Fläche kann HobelInfehler, Splate, Baumrinde vorstellen)

Die Kunststoffgläser werden nicht festgenagelt sondern mit Silikone befestigt (nicht mitgeliefert) oder vorzubohren und geschraubt.

UNTERHALT

Es ist notwendig, das Gartenhaus mit einem pilztötenden, insektenvernichtenden und anti-uva Imprägniermittel speziell für draussen, zu streichen. Min. 2x Aussen und 1x Innen streichen.

Diese Behandlung muss regelmässig gemacht werden.

KUNDENDIENST

Alle Fehlen werden mit dem KD-Formular innerhalb von 10 Tagen nach dem Einkauf angemeldet (verfügbar im Geschäft).

Unser Dienst herstellt oder ersetzt das defekte Stück.

Die anderen Kosten werden nicht angenommen.

Décor et Jardin sa hat keine Verantwortlichkeit, wenn Kunden Änderungen auf Produkten machen.

Für alle Anfrage bitten wir Sie das KD-Formular auszufüllen: Rechnung, Referenz v. Produkt, ganz wichtig die genaue Referenz von dem defekten Stück.

Leggere attentamente i consigli generali preliminari sottoelencati

Vi ringraziamo dell'acquisto di questo riparo, inoltre Vi invitiamo a leggere attentamente le istruzioni prima di disimballare il collo.

Stockaggio del collo prima del montaggio del riparo

Immagazzinate il vostro collo in un luogo asciutto e ventilato, al riparo del sole e delle intemperie (imballaggio non ermetico).

Il collo ed i pezzi devono essere posti piatti sul suolo, per evitare malformazioni.

Procedete al montaggio in un intervallo minimo dopo ricezione del prodotto (il termine di servizio dopo vendita è di al massimo 10 giorni dopo la data d'acquisto).

Istruzioni di sicurezza

I pezzi in legno possono presentare pericoli di schegge. Manipolate il legno con cautela e di preferenza con guanti protettivi. Verificate che nessun chiodo, bullone o punto metallico sporgesse dai pezzi assemblati.

Seguite sempre attentamente le istruzioni e l'ordine di montaggio presente nella seguente nota.

Procedura di montaggio

E' indispensabile d'installare il riparo in un luogo protetto dai venti violenti.

Non esponete i pezzi in legno e il rivestimento del tetto al sole durante il montaggio.

Iniziate a smistare, identificare e verificare i pezzi in base alla nomenclatura, riferendovi alla loro sezione e la loro lunghezza.

Prima di iniziare il montaggio, assicuratevi che la base sulla quale il riparo verrà installato, sia perfettamente piatto, e a livello.

L'opzione pavimento è composto di capriate e di piastre/tavole da assemblare su un suolo stabile e fermo. Mettere dei supporti (blocchi o trave in cemento di min. 40mm di spessore) per assicurare una buona ventilazione.

Per il riparo senza pavimento, la lastra in cemento deve avere delle dimensioni uguali o superiori rispetto alle dimensioni del pavimento. Verificate la squadratura misurando le diagonali.

Tutti i pezzi possiedono la lunghezza corretta, quindi non tagliateli (eccezione fatta di certi tipi di crociere, stecche per vetrate, roofing).

Durante il montaggio controllate regolarmente il livello e la squadratura dei pezzi.

Per tutti i pezzi assemblati con viti, è consigliato di prefurare il primo pezzo, altrimenti il legno potrebbe spaccarsi durante il serraggio.

Rinforzi interni (per riparo massiccio)

Le stecche di rinforzo, da montare all'interno negli angoli, servono ad unire la punta, al corpo del riparo (1 vite alle estremità dei rinforzi). Verificate regolarmente queste fissazioni, e regolatele in funzione al lavoro del legno (sechezza, umidità, ...)

Per i telai fissi di finestre (secondo il modello): prima del fissaggio, è consigliato d'incollare tenone e mortasa dei montanti e traverse con della colla di legno (non fornita).

Potrete ottenere le crociere e le stecche per vetrate delle porte, tagliando il legno nelle dimensioni corrette.

Fissaggio del riparo

Sempre fissare saldamente il riparo al suolo con tutti i mezzi adeguati (non forniti).

In caso dell'opzione pavimento: fissatelo al corpo del riparo, e metteteci del peso per provarlo. I mezzi per il fissaggio non sono inclusi.

Copertura del tetto

Iniziate il montaggio della copertura del tetto dal basso, lasciando sporgere il roofing di 40mm d'avanti e dietro. Ribattete il roofing sui lati del tetto.

Nel caso di roofing nero: lasciate sporgere il roofing di 70mm sul lato, poi ripiegate sotto la lastra del tetto e fissatelo con l'aiuto di chiodi a testa larga (al massimo tutti i 200mm).

Nel caso di roofing verde: lasciate sporgere il roofing di 10mm sui lati e fissatelo con l'aiuto di chiodi a testa larga (al massimo tutti i 200mm).

Terminate mettendo le tavole di sponda con l'aiuto di viti.

Osservazioni

Il legno di abete è una materia viva che lavora in continuazione, e può quindi presentare certe deformazioni (legno leggermente incurvato o deformato), crepe, nodi che cadono e tasche di resina.

Questo è normale e non mette in pericolo la longevità del Vostro riparo. L'applicazione di pasta per legno (non fornita) costituisce una soluzione semplice.

Tutte le tavole, per i ripari ad incastro, hanno sempre una bella faccia che deve essere posta all'esterno del riparo (la faccia nascosta può presentare certi difetti di piallaggio, corteccia, fessure,...).

Non inchiodate i vetri sintetici perché rischiano di spaccarsi. Consigliamo di passarli con del silicone (non incluso) o forandoli prima di avvitarli.

Manutenzione

E' imperativo trattare il riparo con dell'impregnante protettivo per legno che contenga agenti fungicidi, insetticidi e pigmenti resistenti ai raggi U.V. Mettete minimo 2 strati all'esterno + 1 strato all'interno.

Rinnovate l'operazione regolarmente secondo l'usura.

Servizio dopo vendita (SDV)

Utilizzate il formulario SDV (disponibile in negozio) per segnalare ogni reclamo sul riparo. I reclami devono essere segnalati entro i 10 giorni dopo la data d'acquisto.

Il nostro SDV consiste nella riparazione o la sostituzione del pezzo difettoso. Le eventuali spese di montaggio e smontaggio non vengono prese in carica.

Ogni intervento su un prodotto senza convalida preliminare da parte di Décor et Jardin, esenta la ditta Décor et Jardin di ogni responsabilità.

Per tutte le richieste di SDV, rispettate la procedura disponibile in negozio (procedura SDV) munedovi di scontrino o prova d'acquisto, referenza del prodotto e referenza del pezzo difettoso.

Consejos generales previos. Leer atentamente.

Le agradecemos por haber comprado esta caseta, y le invitamos a leer atentamente las instrucciones antes de empezar a abrir el paquete.

Almacenaje del paquete antes de montar la caseta

Guarde el paquete en un sitio seco y ventilado, protegido de la luz y de las intemperies (embalaje no hermético).

Extienda el paquete y las piezas en el suelo para evitar que se deformen.

Realice el montaje en un plazo mínimo después de haber recibido el producto (el plazo máximo de servicio posventa es de 10 días después de la fecha de compra).

Precauciones de seguridad

Las piezas de madera pueden presentar riesgos de astilla. Manipule la madera con precaución, usando guantes de protección.

Verifique que no haya ningún clavo, tornillo o grapa saliendo de las piezas ensambladas.

Seguir siempre atentamente las presentes instrucciones y el orden de montaje.

Montaje

Es imprescindible colocar la caseta en un sitio protegido de los vientos fuertes.

No exponer al sol las piezas de madera ni el revestimiento del techo durante el montaje.

Empezar con seleccionar, identificar y verificar las piezas con respecto a la nomenclatura, atendiendo a su forma y a su longitud.

Antes de empezar, asegúrese de que la superficie en la cual se va a colocar la caseta sea perfectamente plana, y nivelada.

El suelo de la caseta está compuesto por espigas y tablas que hay que ensamblar encima de un suelo firme y estable. Colocar soportes (bloques o vigas de hormigón de 40 mm mínimo de grosor) para garantizar una buena ventilación.

Para la caseta sin suelo, la losa de hormigón debe tener dimensiones iguales o superiores a las del suelo. Verifique el ángulo midiendo las diagonales.

Todas las piezas vienen ya con las dimensiones adecuadas, no cortarlas (excepto algún tipo de celosía, listones de acristalamiento y material de techado).

Controlar regularmente el nivel y el ángulo de lo que está ensamblando.

Para todas las piezas ensambladas con tornillo, se aconseja perforar la primera pieza, sino puede que la madera se parta al hacer presión.

Refuerzos interiores (si caseta maciza)

Los listones de refuerzo, que se colocan en las esquinas interiores, sirven para solidarizar los extremos al cuerpo de la caseta (un único tornillo en los extremos de los refuerzos). Revise con regularidad las fijaciones, y ajústelas según el estado de la madera (sequedad, humedad,...).

Para los contramarcos fijos de las ventanas (según modelo): antes de atornillar, se aconseja encolar las espigas y muescas de los montantes y travesaños con cola para madera (no incluida).

Se obtendrán la celosía y los listones de acristalamiento de las puertas y ventanas cortando la madera según las

dimensiones adecuadas.

Fijación de la caseta

Fijar fuertemente la caseta al suelo de cualquier modo adecuado (medios no incluidos).

Para una caseta con suelo: fijarlo al cuerpo de la caseta, y añadir peso para lastrarlo. Los medios de fijación no están incluidos.

Techo

Empezar la instalación del revestimiento del techo por la parte baja, dejándolo sobresalir 40 mm por delante y por detrás. Doblarlo en el canto del techo.

Para techo negro: dejar sobresalir el revestimiento 70 mm por los lados, doblarlo debajo del techo y fijarlo con los clavos de cabeza ancha (cada 200 mm máximo).

Para techo verde: dejar sobresalir el revestimiento 10 mm por los lados, y fijarlo con los clavos de cabeza ancha (cada 200 mm máximo).

Acabar colocando los cantos de tejado con tornillos.

Observaciones

La madera de pino es un material vivo, que no deja de madurar y puede presentar algunas deformaciones (madera ligeramente torcida o combada), grietas, nudos caídos y bolsas de resina.

Esto es normal, y no pone en peligro el aguante o duración de su caseta. La aplicación de pasta de madera (no incluida) puede ser una solución sencilla.

Para las casetas de sistema de encaje, tener en cuenta que toda las tablas tienen siempre un lado bonito que debe colocarse hacia el exterior de la caseta (la cara oculta puede presentar algunos defectos de nivelado, corteza, grietas,...) Los vidrios sintéticos no deben clavarse por riesgo de rotura. Le aconsejamos fijarlos con silicona (no incluida) o perforarlos antes de atornillarlos.

Limpieza

Es imprescindible limpiar la caseta con la ayuda de un producto de protección para la madera en exteriores, que contenga agentes fungicidas, insecticidas y anti-UV. Mínimo de 2 capas en el exterior + 1 capa en el interior.

Realice la operación regularmente según el desgaste.

Servicio post-venta (SPV)

Cualquier defecto o falta debe indicarse mediante el formulario de SPV (disponible en tienda) en un plazo de 10 días siguientes a la compra, presentando factura o ticket de caja.

Nuestro servicio de Post-venta procederá a la reparación o reemplazo de la pieza defectuosa. No nos hacemos cargo de los posibles gastos de instalación o desinstalación.

Todo cliente que tome la iniciativa de intervenir sobre un producto sin previa autorización por parte de Décor et Jardin SA exculpará a Décor et Jardin SA de toda responsabilidad.

Para cualquier petición al SPV, siga estrictamente el procedimiento disponible en la tienda. (Procedimiento SPV): Ticket de caja o prueba de compra, referencia del producto, referencia exacta de la pieza defectuosa.

Conselhos gerais preliminares a ler atentamente

Agradecemos a aquisição deste chalé e convidamo-lo a ler atentamente estas instruções antes de abrir a embalagem.

Armazenamento da embalagem antes de montar o abrigo

Armazene a embalagem num local seco e ventilado, protegida do sol e das intempéries (embalagem não hermética). A embalagem e as peças devem ser colocadas sobre uma superfície nivelada para evitar possíveis deformações. Monte o produto no mais breve espaço de tempo possível após a recepção do mesmo (o prazo de devolução ao serviço pós-venda é de 10 dias após a data de aquisição).

Conselhos de segurança

As peças em madeira podem ter farpas. Manipule as peças em madeira com precaução, utilizando luvas de protecção. Certifique-se de que as peças montadas não possuem pregos, parafusos ou agrafos salientes. Siga sempre atentamente as instruções e a ordem de montagem descritas neste folheto.

Operação de montagem

É indispensável que o abrigo seja instalado num local protegido de ventos violentos.

Não exponha as peças de madeira e o revestimento da cobertura ao sol durante a montagem.

Comece por separar, identificar e verificar as peças em relação à lista fornecida, tendo em consideração a respectiva secção e comprimento.

Antes de começar, certifique-se de que a base sobre a qual vai instalar o abrigo está perfeitamente plana e nivelada.

A opção com soalho é composta por vigas e placas/pranchas a montar sobre um solo firme e estável. Utilize suportes (blocos ou vigas de betão com uma espessura mínima de 40 mm) para garantir uma boa ventilação.

Se o abrigo não incluir soalho, a laje de betão deve possuir dimensões semelhantes ou superiores às do soalho. Verifique a esquadria medindo as diagonais.

As peças possuem as dimensões correctas, pelo que não deverão ser cortadas (à excepção de determinados tipos de pinázios, de ripas de montagem dos vidros e de armações de telhado).

Verifique regularmente o nivelamento e a esquadria das peças montadas.

No caso das peças montadas com parafusos, aconselha-se a perfurar previamente a primeira peça, caso contrário a madeira poderá rachar durante o aperto das peças.

Reforços interiores (no caso de abrigos maciços)

As ripas de reforço a colocar nos ângulos, no interior, servem para fixar as extremidades ao corpo do abrigo (1 único parafuso nas extremidades dos reforços). Verifique regularmente estas fixações e ajuste-as em função do empenamento da madeira (secura, humidade,...)

Para as molduras fixas das janelas (consoante o modelo): antes de aparafusar, é aconselhável colar os entalhes e os encaixes das couceiras e das travessas com cola para madeiras (não fornecida).

Conseguirá obter os pinázios e as ripas de montagem dos vidros das portas e janelas cortando a madeira nas dimensões adequadas.

Fixação do abrigo

Fixe sempre o abrigo ao solo de forma sólida utilizando todos os meios adequados (não fornecidos).

Se optar pela aplicação de soalho: fixe o soalho ao corpo do abrigo e aplique peso a servir de lastro. Os meios de fixação não são fornecidos.

Cobertura

Inicie a colocação do revestimento da cobertura pela parte inferior do tecto, deixando um excesso de 40 mm na frente e atrás, e assentando-o nos cantos do tecto.

No caso de uma armação preta: deixe um excesso de 70 mm nas secções laterais, dobrando posteriormente sob a placa do tecto e fixando com a ajuda de pregos de cabeça larga (no máximo, a cada 200 mm).

No caso de uma armação verde: deixe um excesso de 10 mm nas secções laterais e fixe o revestimento com a ajuda de pregos de cabeça larga (no máximo, a cada 200 m).

Termine aplicando as pranchas dos rebordos com o auxílio de parafusos.

Observações

A madeira de abeto é um material vivo que não cessa de empenar e pode apresentar determinadas deformações (madeiras ligeiramente empenadas ou curvadas), fendas, nódulos pendentes e bolsas de resina.

É uma situação normal e não põe em perigo o período de vida útil do abrigo. Uma solução simples poderá ser a aplicação de pasta de madeira (não fornecida).

No caso de abrigos com encaixes, tenha em atenção que todas as pranchas possuem sempre um lado correcto para ficar virado para o exterior do abrigo (o lado oculto pode apresentar determinados defeitos de aplainamento, crostas e fendas,...)

Não utilize pregos para fixar os vidros sintéticos pois poderão rachar. Fixe os vidros com silicone (não fornecido) ou perfure-os antes de os aparafusar.

Manutenção

Deverá tratar o abrigo com a ajuda de um produto de protecção para madeiras de exterior, que contenha agentes fungicidas, insecticidas e anti-UV. Aplique pelo menos 2 camadas no exterior e 1 camada no interior.

Efectue regularmente esta operação de manutenção, consoante o uso dado ao abrigo.

Serviço pós-venda

As peças em falta devem ser assinaladas no formulário do serviço pós-venda (disponível nas nossas lojas) num período de 10 dias após a aquisição, sendo igualmente necessário apresentar a factura ou o recibo de compra.

O nosso serviço pós-venda consiste na reparação ou na substituição da peça defeituosa. Não serão cobrados eventuais custos de montagem ou desmontagem.

A Décor et Jardin SA declinará qualquer responsabilidade decorrente de possíveis intervenções efectuadas pelos clientes num determinado produto sem a autorização prévia da Décor et Jardin SA.

Para esclarecer dúvidas ou efectuar qualquer pedido ao serviço pós-venda, utilize apenas o procedimento disponível nas nossas lojas (procedimento do serviço pós-venda): tenha sempre disponível a factura ou o comprovativo de compra, a referência do produto e a referência exacta da peça defeituosa.

Abri 2,33×2,33m - mono-pente - poteaux - SF/DPV

52115S160

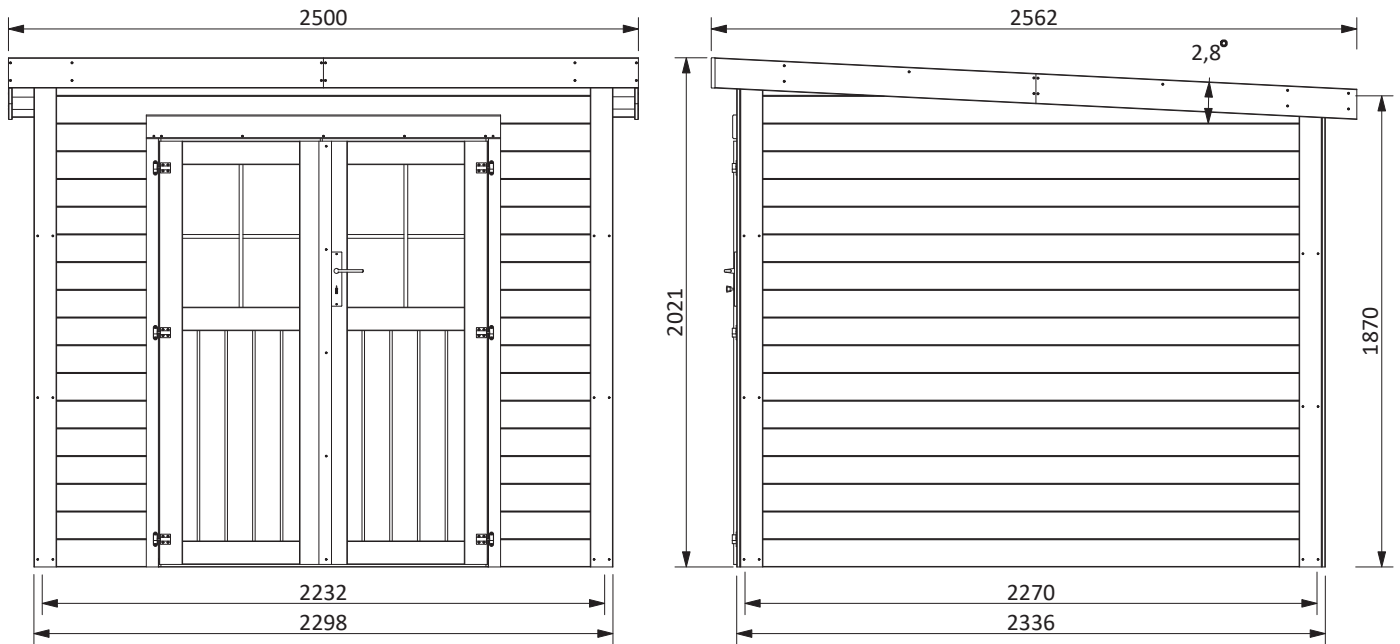

- (EN) Laying on concrete slabs (*not included*)
- (FR) Pose sur dalle béton (*non incluse*)
- (NL) Plaatsen op betontegel (*niet inbegrepen*)
- (DE) Montage auf Betondielen (*nicht einbegriffen*)
- (IT) Posto su pavimenti in cemento (*non incluso*)
- (ES) Colocar sobre losa de hormigón (*non incluida*)
- (PT) Montagem sobre laje de betão (*não incluído*)

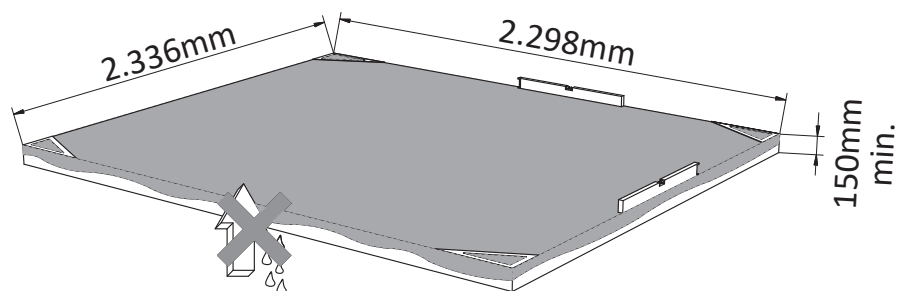

600504 : x2
14x900/900mm

600522 : x2
14x900/1622mm

600588 : x1
14x670/1622mm

503497 : x1
28x94/1406mm

503495 : x1
47x58/1310mm

503567 : x32
19x110/456mm

420196 : x1
650x1680mm

420197 : x1
650x1680mm

500818 : x1
12x50/1680mm

600589 : x1
14x670/900mm

503049 : x4
15x120/1275mm/87,2

502378 : x12
29x59/100mm

503054 : x2
19x110/2270mm

503047 : x4
14x90/1880mm

503050 : x4
14x90/1986mm

503048 : x2
14x90/1235mm

503566 : x2
28x94/2232mm

500062 : x4
24x38/200mm

500220 : x2
29x59/1876mm

503053 : x53
19x110/2270mm

503051 : x2
15x120/1250mm

503507 : x1
14x90/1406mm

500061 : x2
24x38/150mm

50957 : x2
15x20/592mm

50192 : x2
15x20/500mm

500960 : x2
29x59/1980mm

503494 : x2
58x58/1733mm

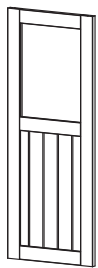

420196 ← : 1
650×1680mm
420197 → : 1
650×1680mm

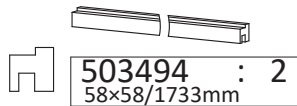

503494 : 2
58×58/1733mm

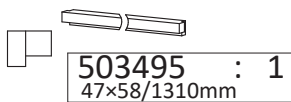

503495 : 1
47×58/1310mm

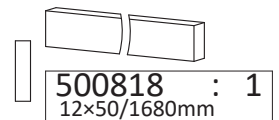

500818 : 1
12×50/1680mm

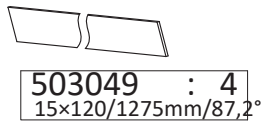

503049 : 4
15×120/1275mm/87,2°

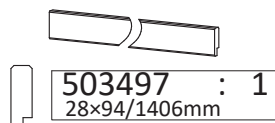

503497 : 1
28×94/1406mm

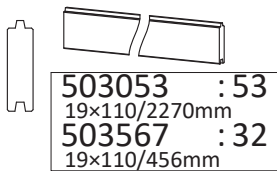

503053 : 53
19×110/2270mm
503567 : 32
19×110/456mm

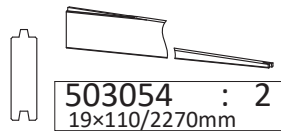

503054 : 2
19×110/2270mm

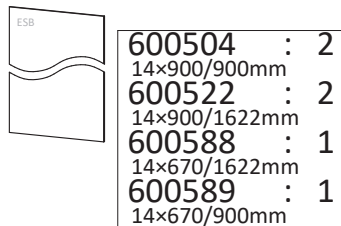

600504 : 2
14×900/900mm
600522 : 2
14×900/1622mm
600588 : 1
14×670/1622mm
600589 : 1
14×670/900mm

503048 : 2
14×90/1235mm
503507 : 1
14×90/1406mm
503047 : 4
14×90/1880mm
503050 : 4
14×90/1986mm
503051 : 2
15×120/1250mm
50192 : 2
15×20/500mm
50957 : 2
15×20/592mm
500061 : 2
24×38/150mm
500062 : 4
24×38/200mm
503566 : 2
28×94/2232mm
502378 : 12
29×59/100mm
500220 : 2
29×59/1876mm
500960 : 2
29×59/1980mm

Kit 700331

	3010	∅3,5×16mm	5
	3011	∅3,5×20mm	8
	3012	∅3,5×25mm	71
	3013	∅3,5×30mm	16
	3014	∅3,5×35mm	42
	3023	∅4×40mm	389
	3027	∅4×60mm	80
	3029	∅4×70mm	2
	3045	∅5×80mm	2

	3505	∅1×25mm	8

	2915	∅4mm	1

Kits 700043 + 700062

	3810	∅2×15mm	110

Plexy

	750039	489×591/1,5mm	2



Kit 700329



	2450	1		2081	6
	2113	1		2163	2



Kit 700210



	2381	60×60mm	2
	2271	1.310mm	1
	800004	1,00×9m	1

1

503567  = 16x 
19x110/456mm

503567  = 16x 
19x110/456mm

503053  = 34x 
19x110/2270mm

503053  = 19x 
19x110/2270mm

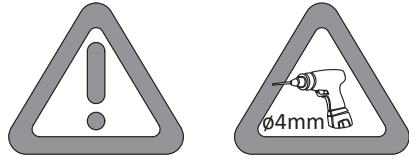



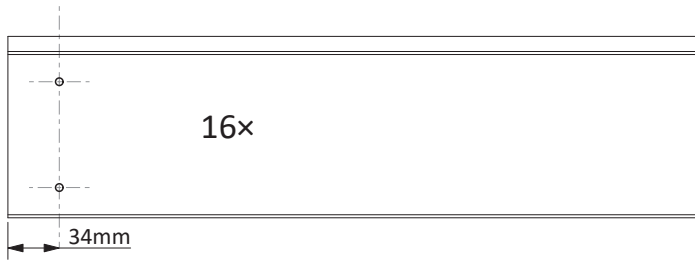



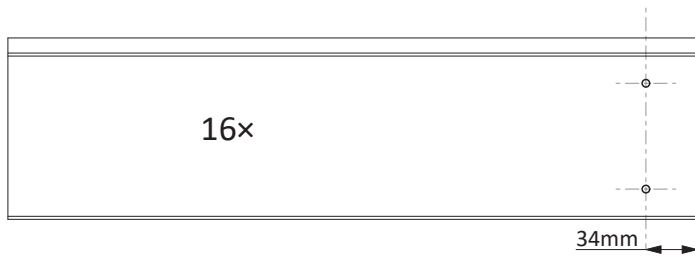



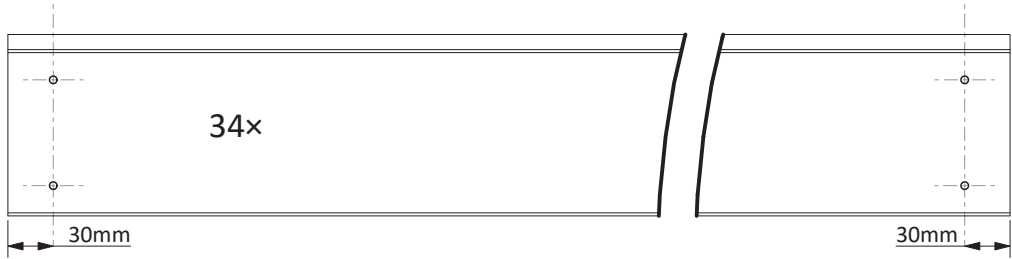



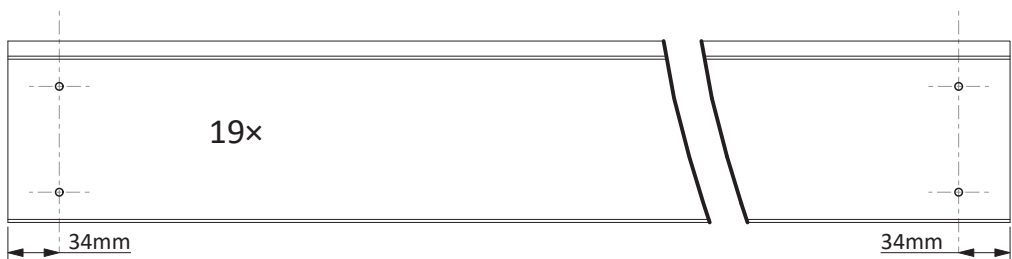

2

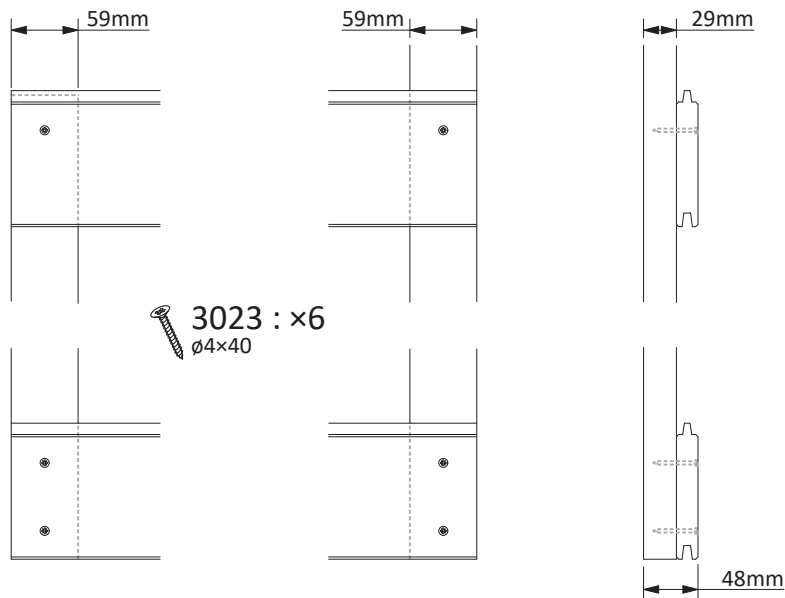
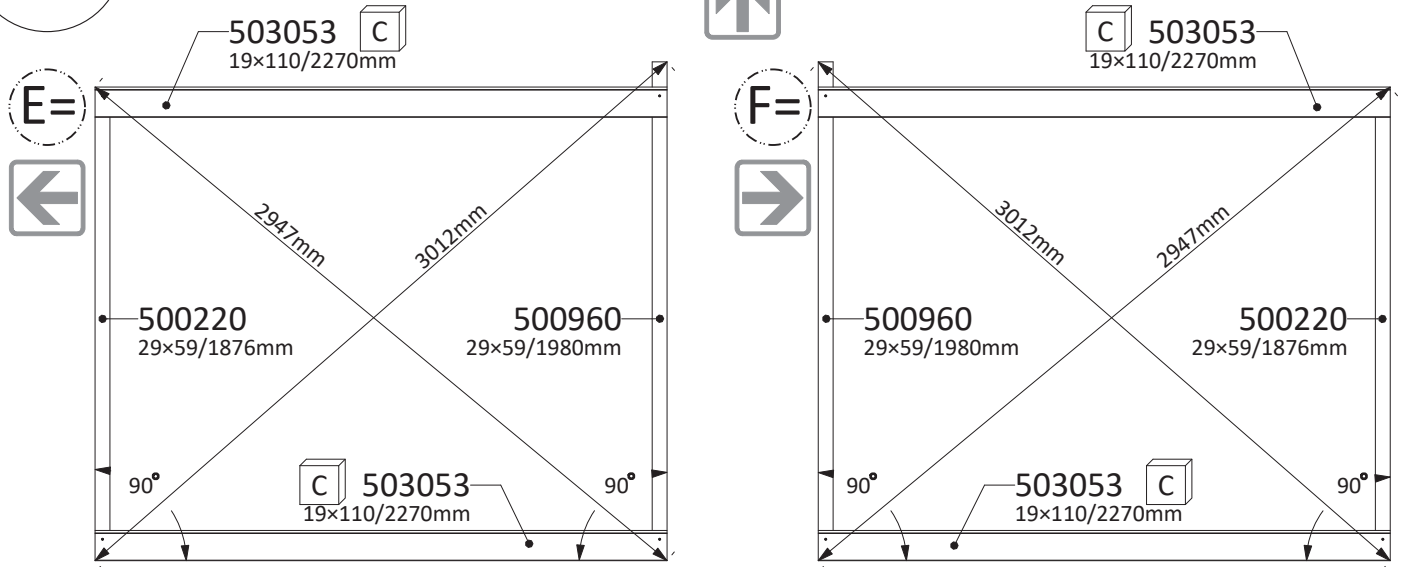

3

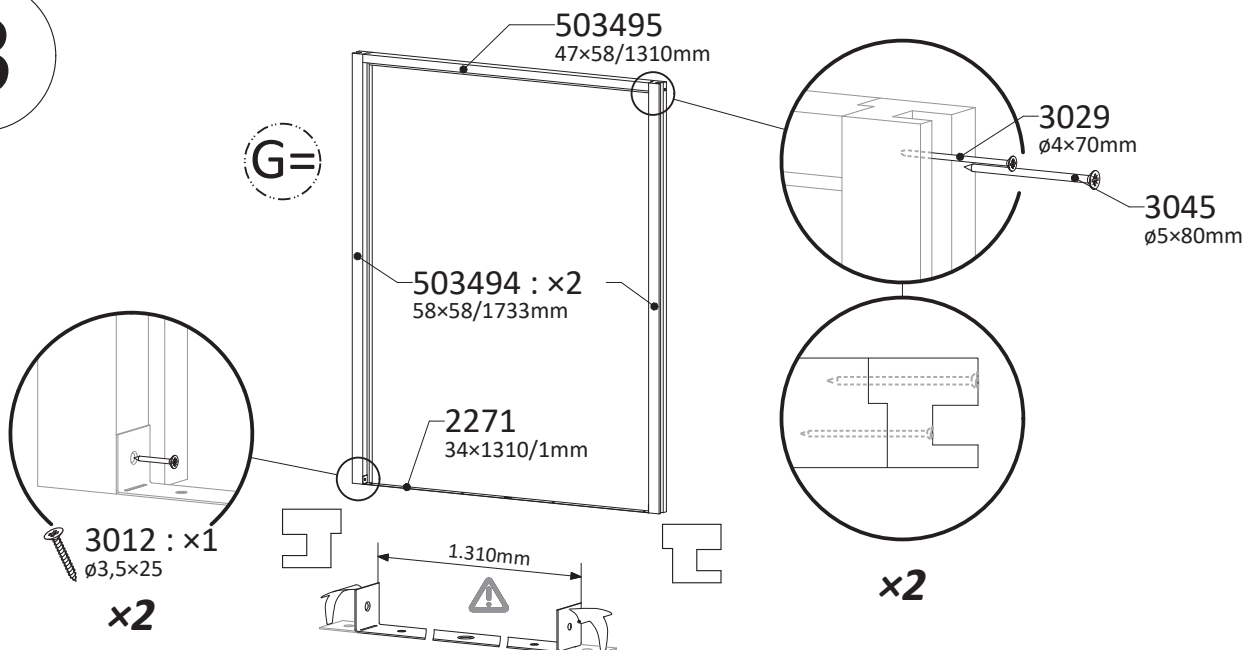

4

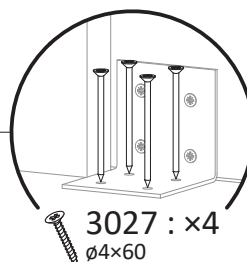
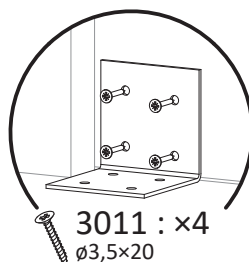
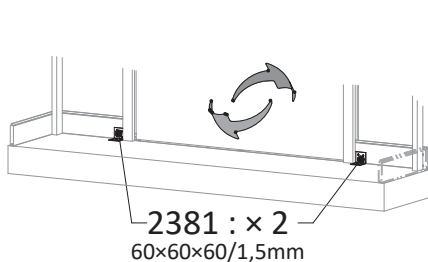
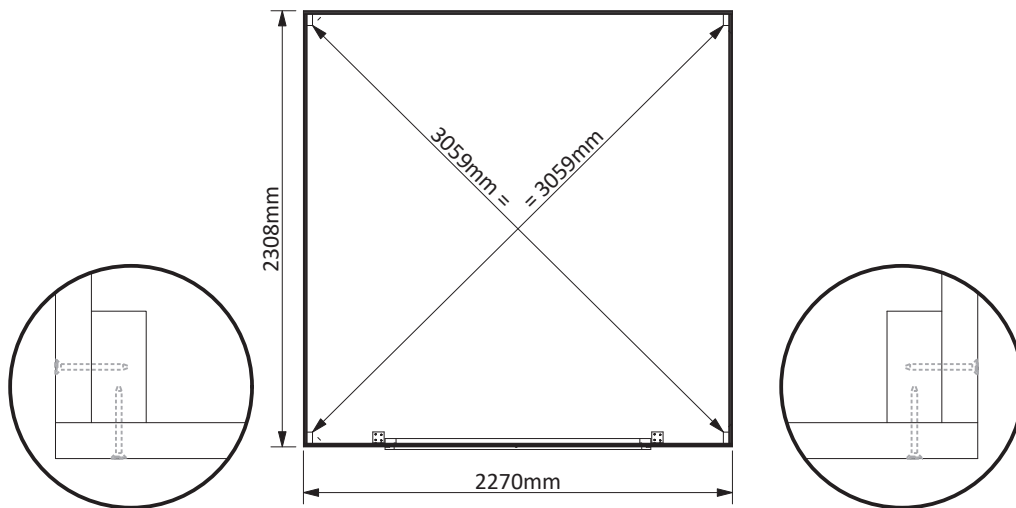
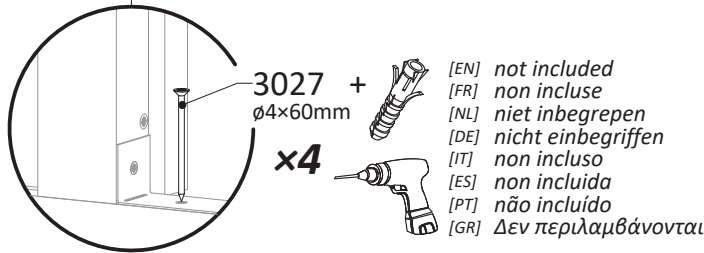
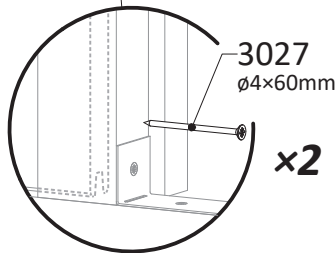
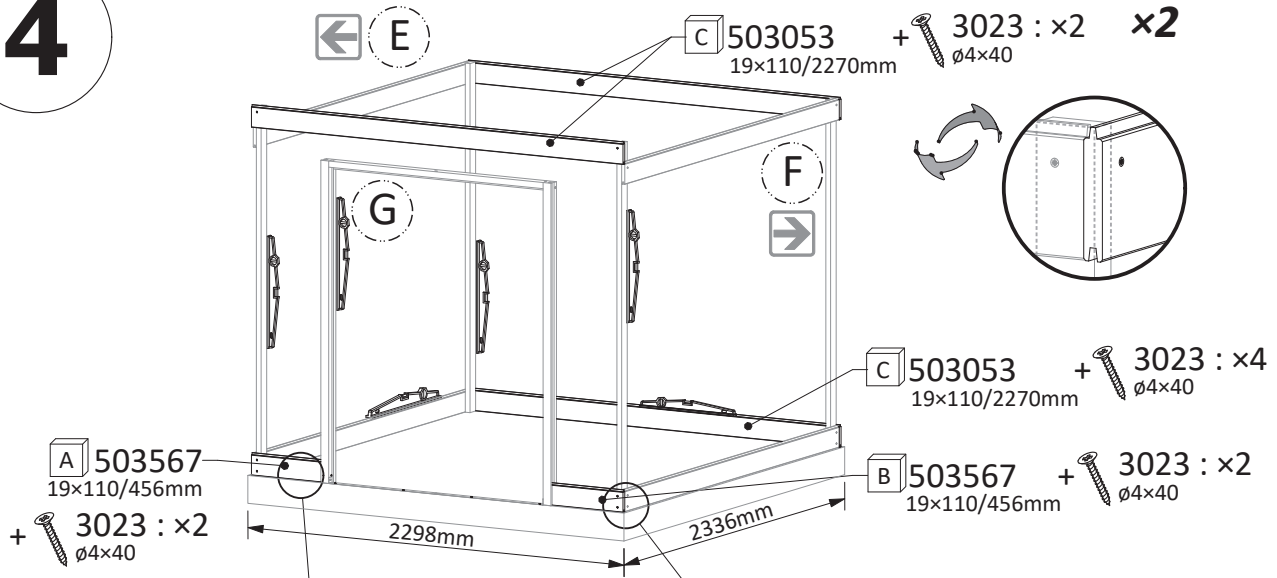

[EN] not included
[FR] non incluse
[NL] niet inbegrepen
[DE] nicht einbegriffen
[IT] non incluso
[ES] non incluida
[PT] não incluído
[GR] Δεν περιλαμβάνονται

5

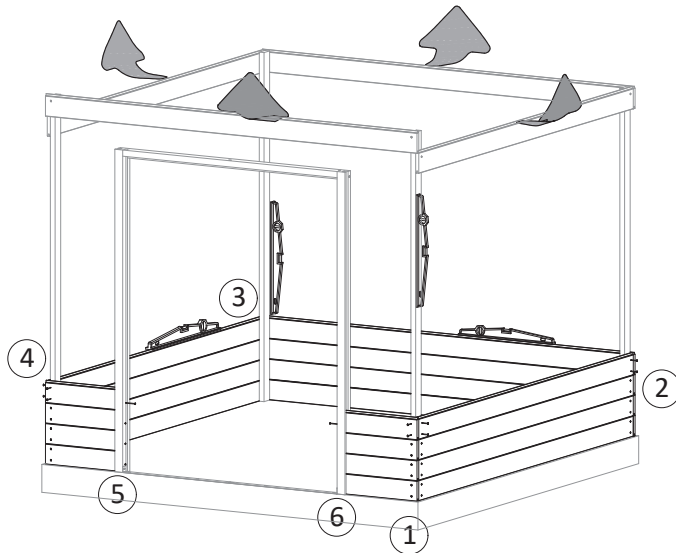

3023
ø4x40

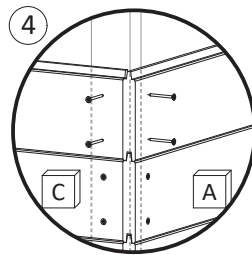
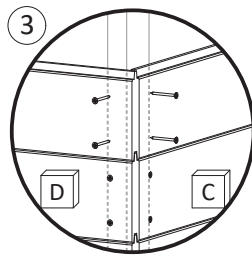
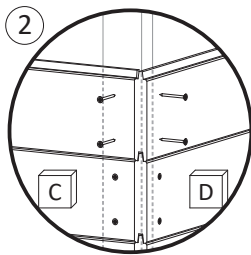
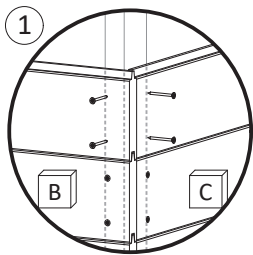

3027
ø4x60

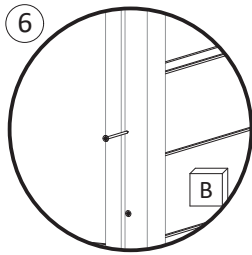
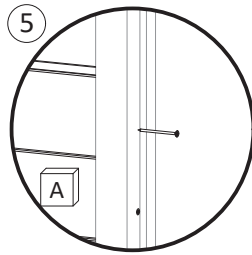

6

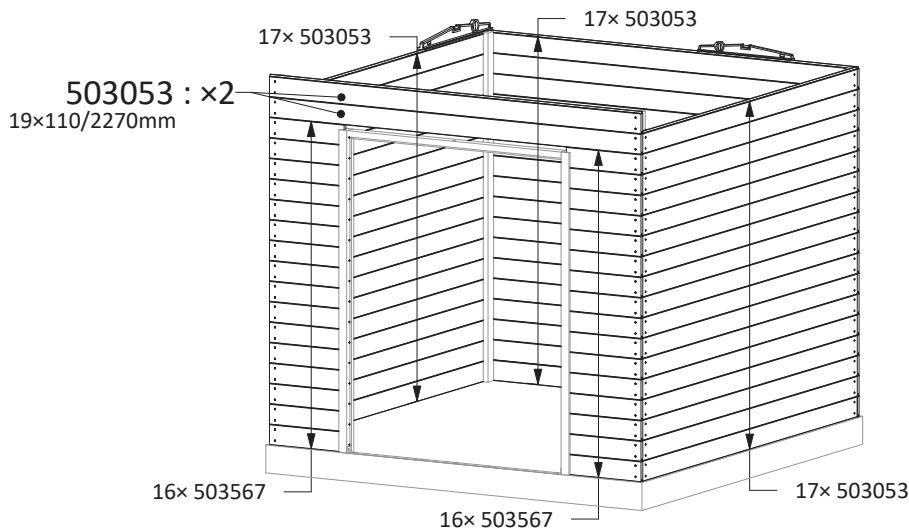

3023 : x276 = 17x16 + 4
ø4x40

3027 : x32 = 16x2
ø4x60

7

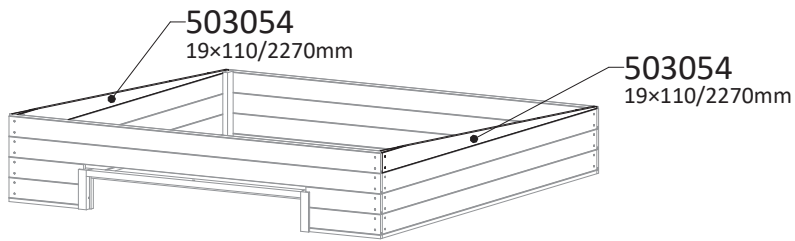

3023 : x2
ø4x40

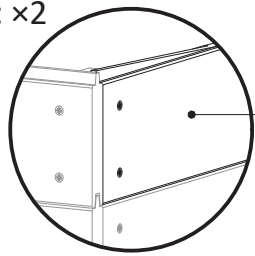

503054
19x110/2270mm

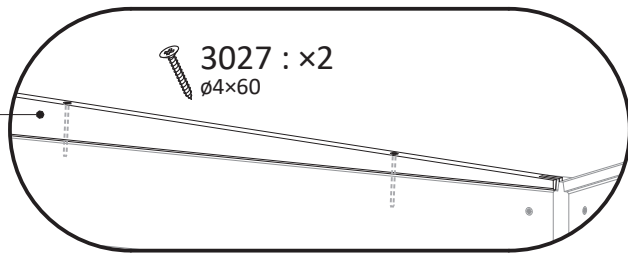

x2

8

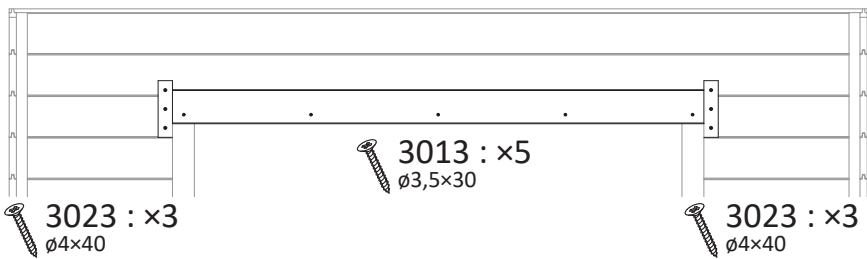
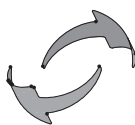
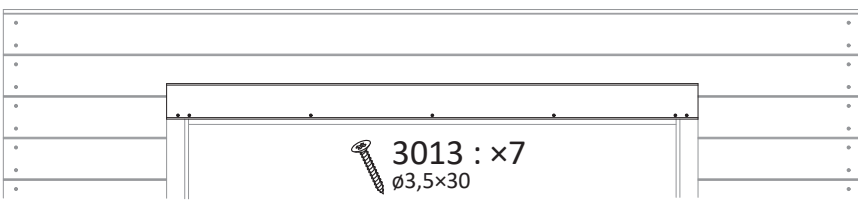
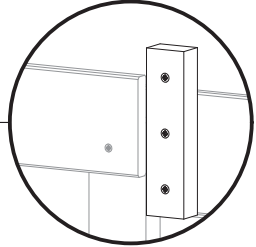
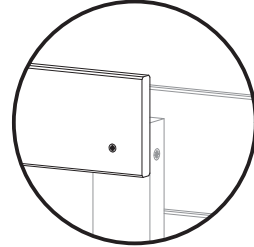
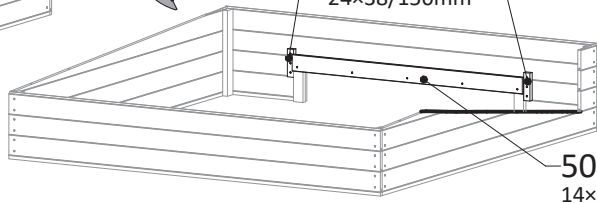
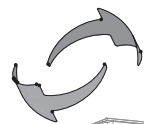
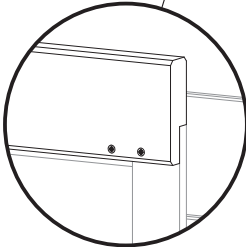
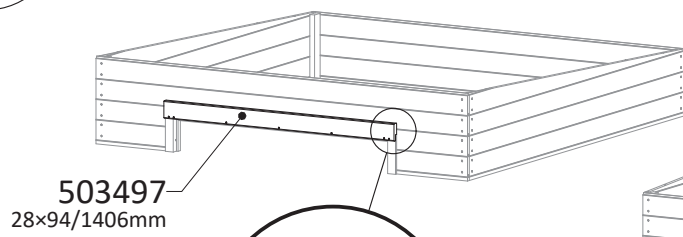

9

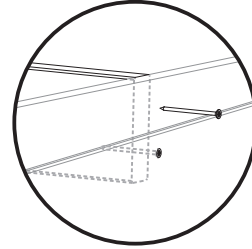
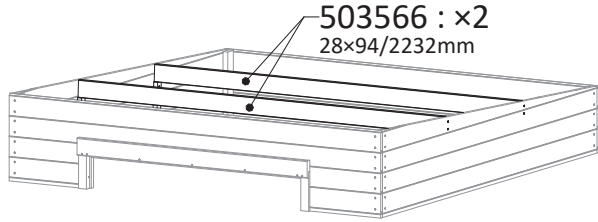

x4

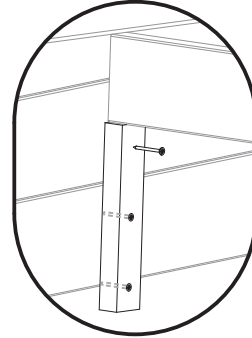
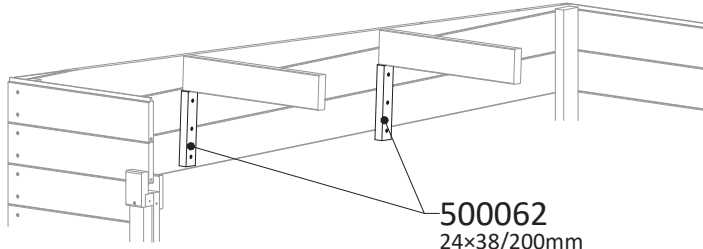

x4

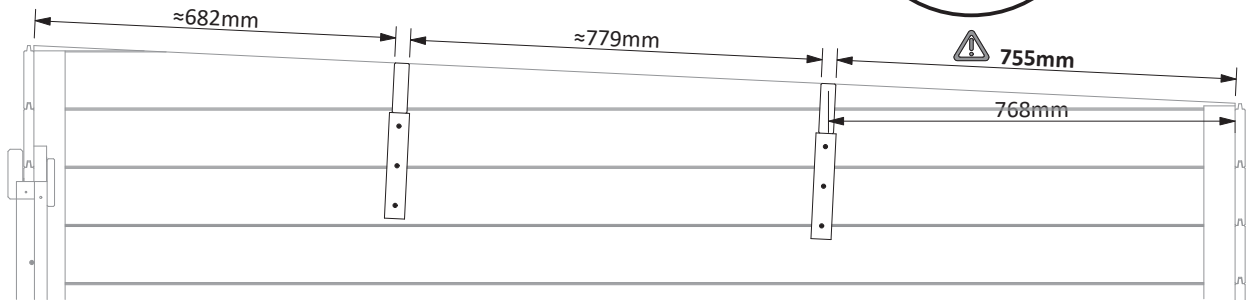

10

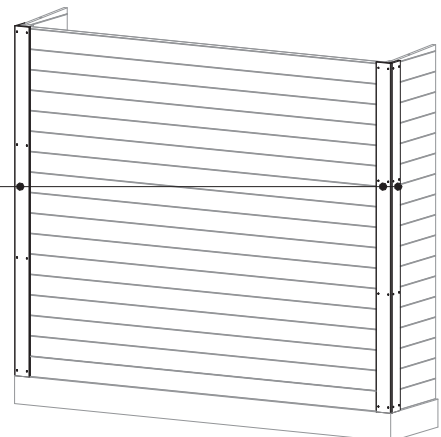
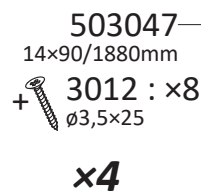
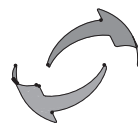
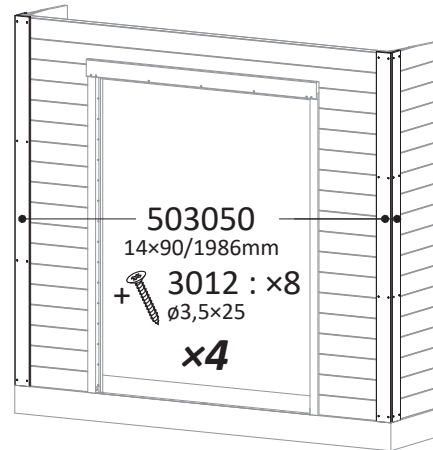
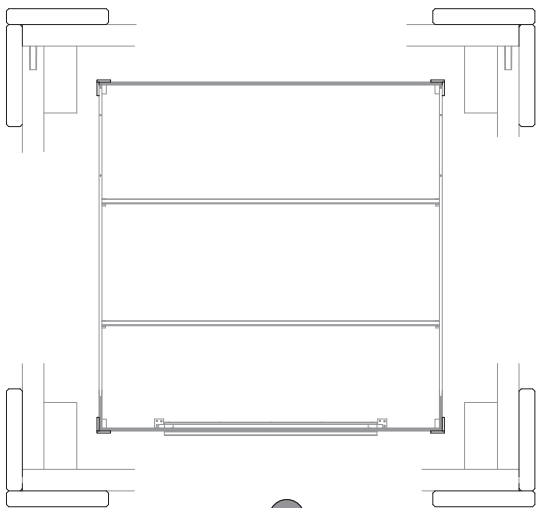

11

600589
14x670/900mm
600588
14x670/1622mm
600522 : x2
14x900/1622mm

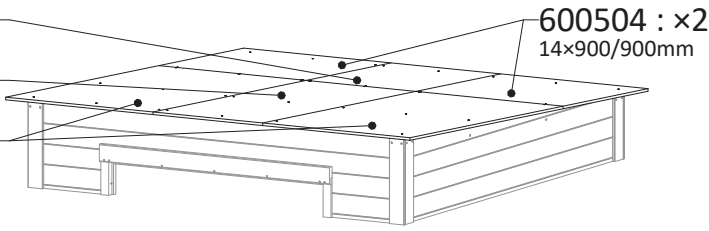

3023 : x9 x5 = 45
ø4x40

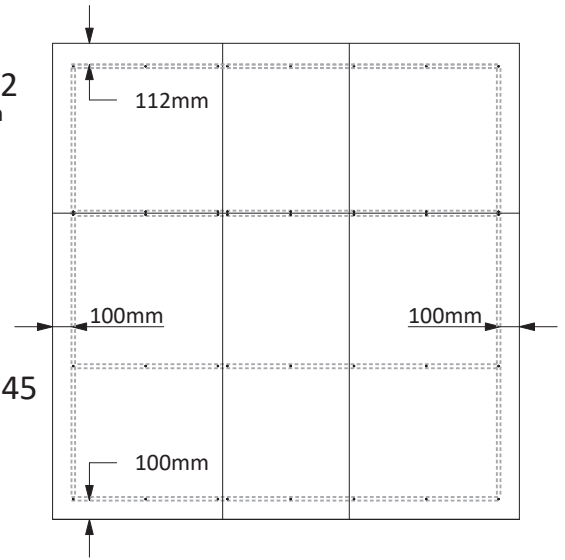

12

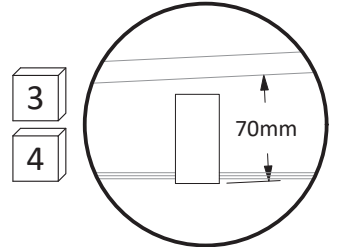
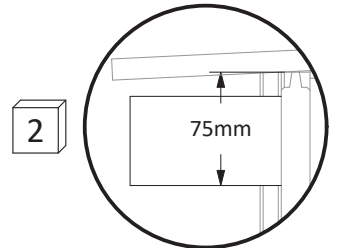
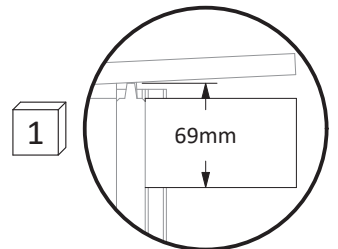
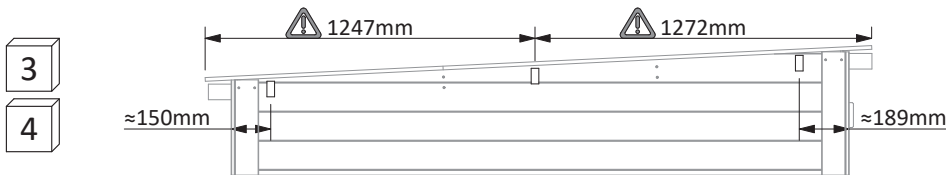
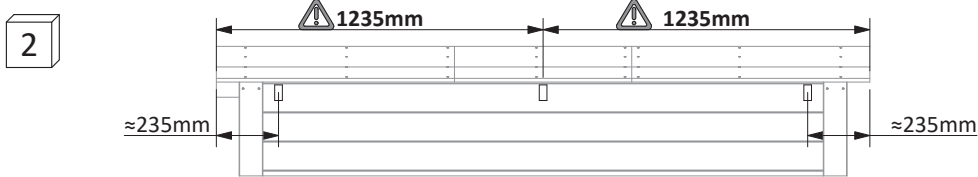
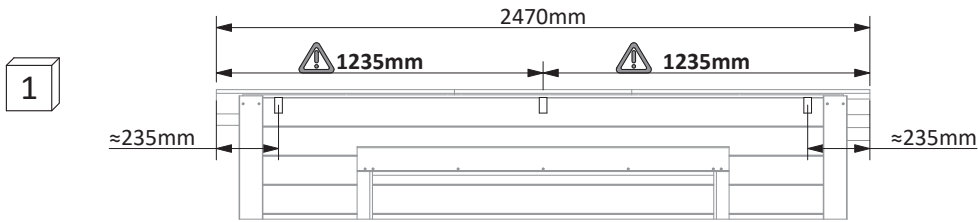
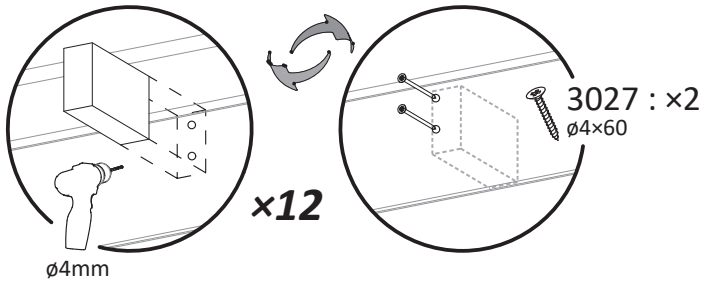
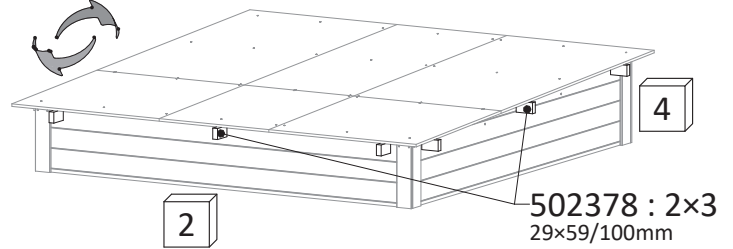
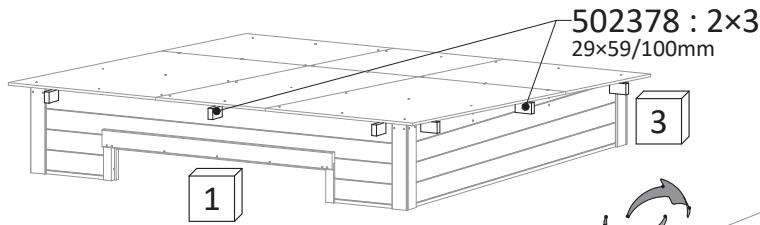

13

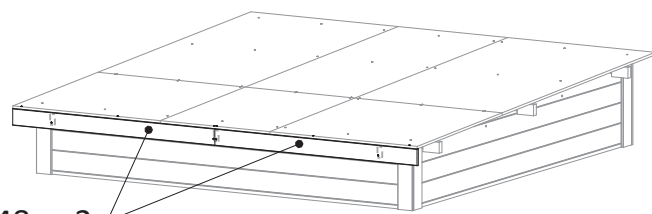

503048 : x2
14x90/1235mm

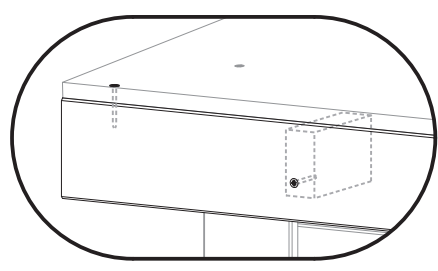

3023 : x4
ø4x40mm

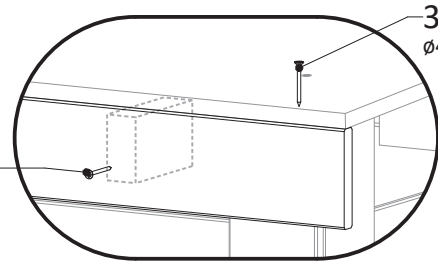

3023 : x6
ø4x40mm

14

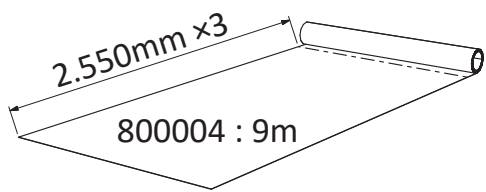

[EN] not included
[FR] non incluse
[NL] niet inbegrepen
[DE] nicht einbegriffen
[IT] non incluso
[ES] non incluida
[PT] não incluido
[GR] Δεν περιλαμβάνονται

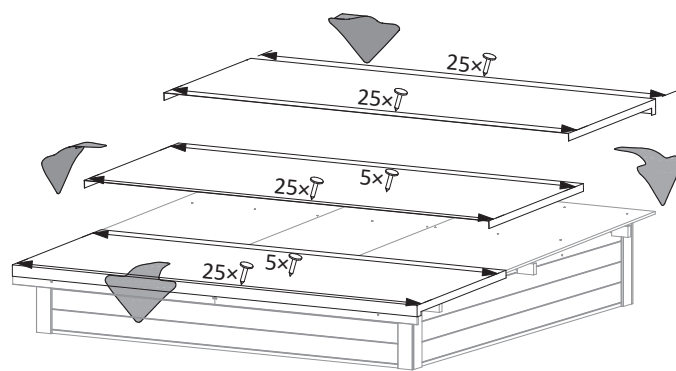

3810 : x110
15mm

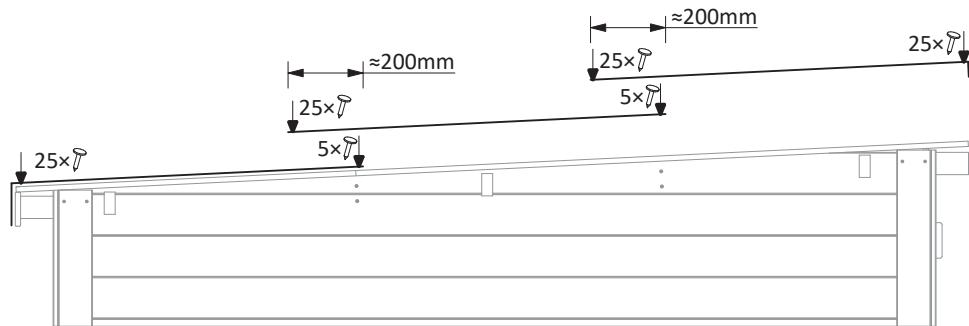

15

503049 × 2
15×120/1275mm/87,2°
+ 3023 : ×12
ø4×40

503051 × 2
15×120/1250mm
+ 3023 : ×12
ø4×40

503049 × 2
15×120/1275mm/87,2°
+ 3023 : ×12
ø4×40

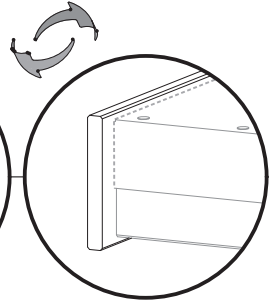
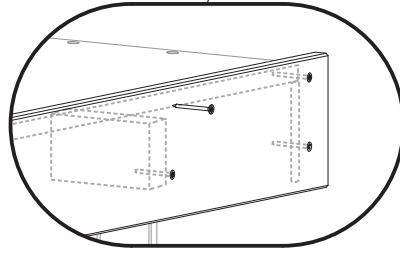
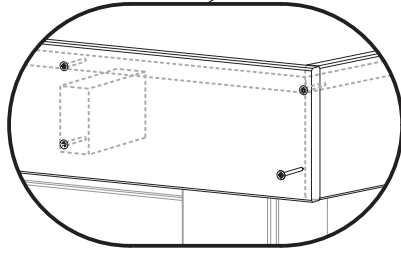
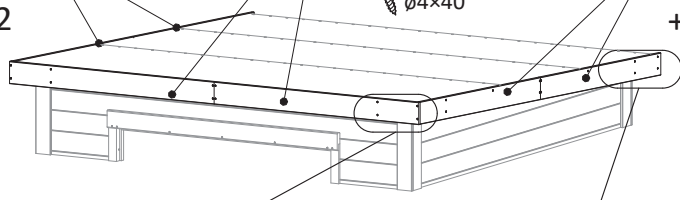

16

420196 ←
650×1680mm
420197 →
650×1680mm

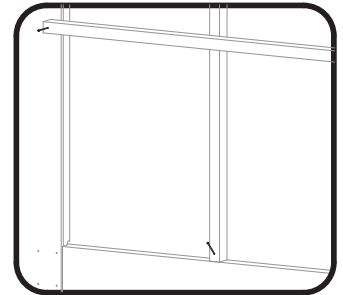
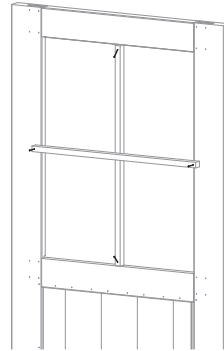
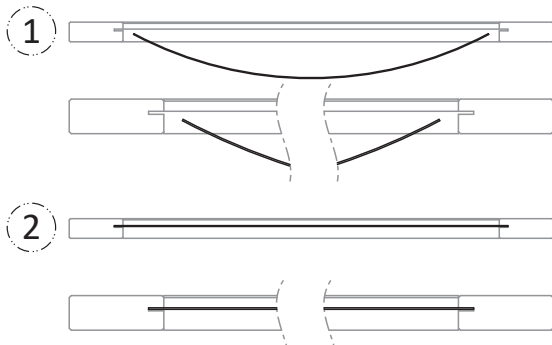
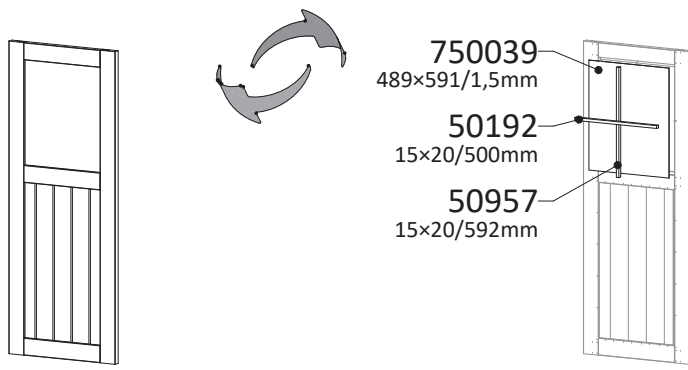

3505 : x4
25mm

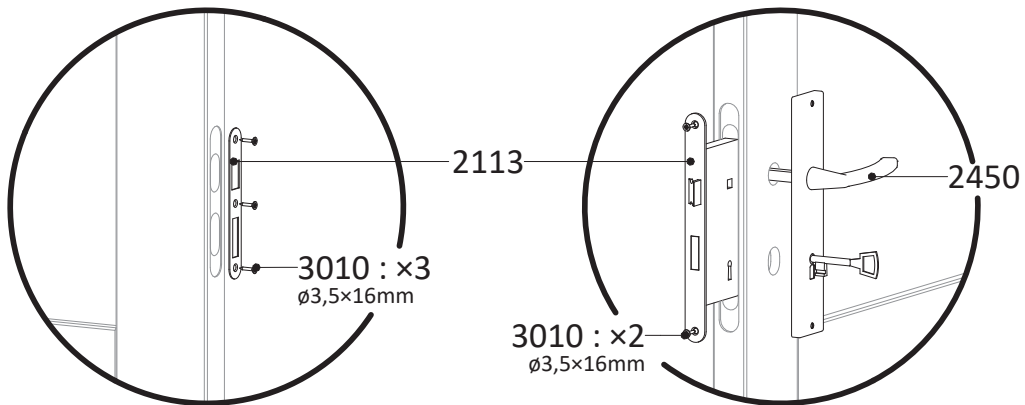

420196 ←
650×1680mm

420197 →
650×1680mm



**Silicone
Silikon**
(not included)
(non inclus)
(niet inbegrepen)
(nicht einbegriffen)
(non incluso)
(non incluida)
(non incluido)

17

2081 : x6

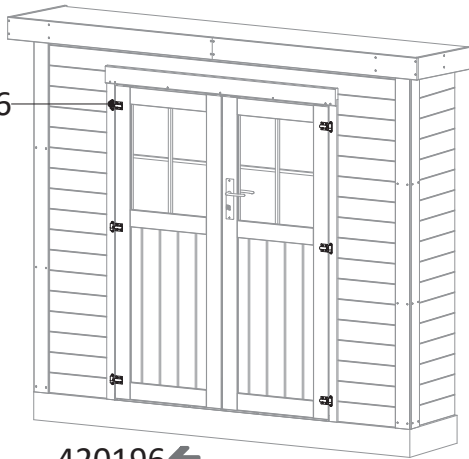
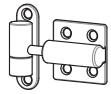

420196 ←
650x1680mm

420197 →
650x1680mm

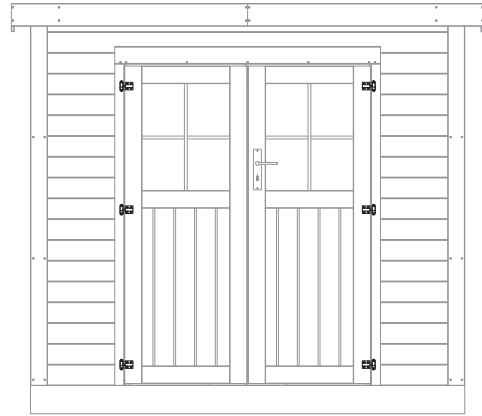

500818
12x50/1680mm
+ 3012 : x5
ø3,5x25

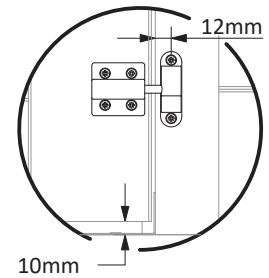
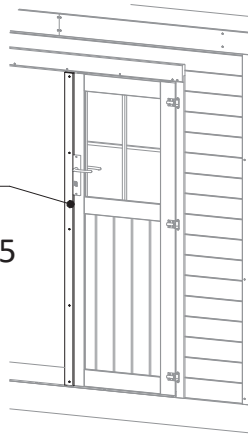

3014 : x7
ø3,5x35

x6

2163 : x2

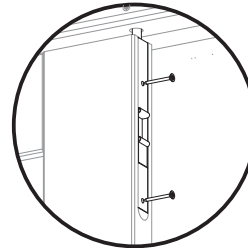
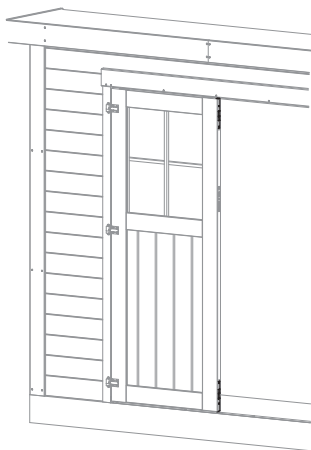
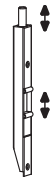

3030 : x2
ø3,5x30

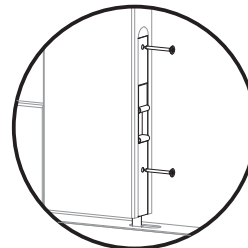

3030 : x2
ø3,5x30



**Abri 2,33×2,33m - mono-pente -
poteaux - SF/DPV
52115S160**

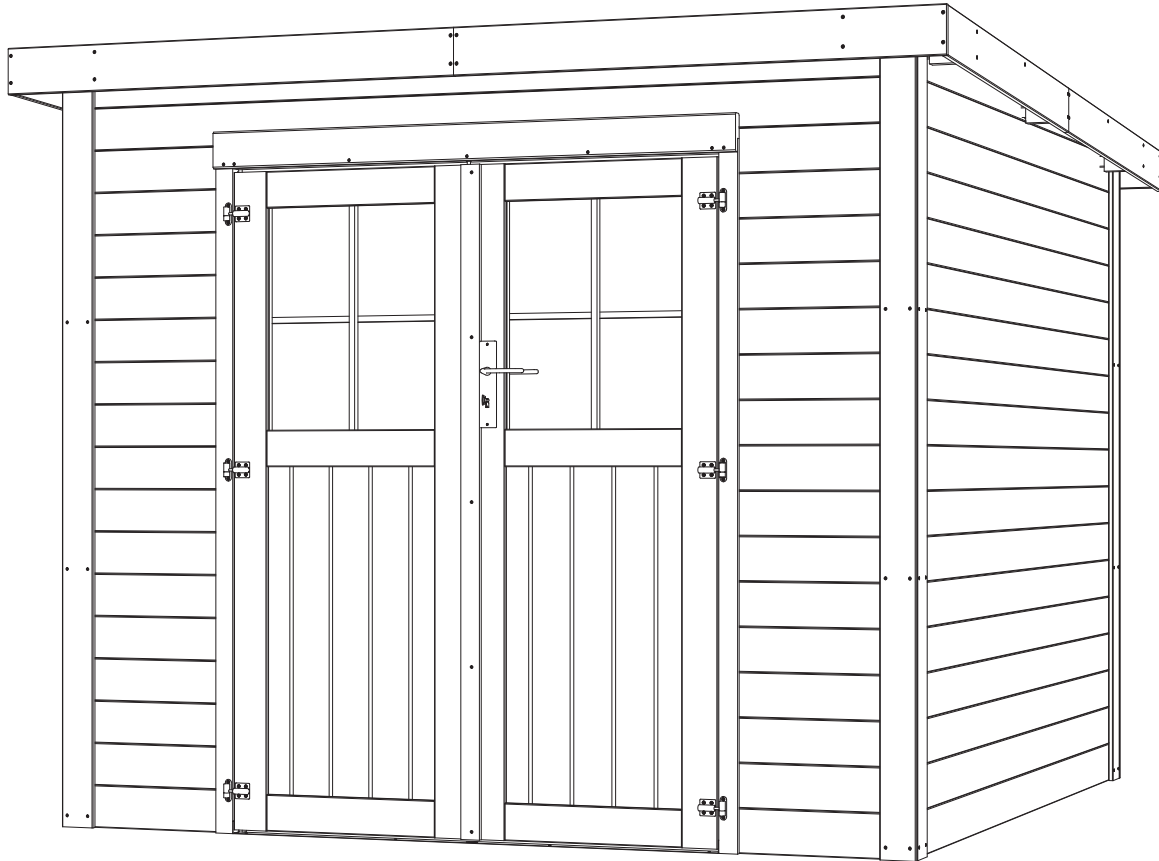

- (EN) **Assembly notice - keep for later reference.**
(FR) **Notice de montage à conserver pour consultations ultérieures.**
(NL) **Te bewaren gebruiksaanwijzingen voor latere raadplegingen.**
(DE) **Montageanleitung nicht wegwerfen, bewahren Sie diese für später.**
(IT) **Manuale di montaggio da conservare per ulteriori consultazioni.**
(ES) **Debe conservar las instrucciones de montaje para consultas posteriores.**
(PT) **Instruções de montagem a guardar para consultas futuras.**

Fabriqué par Décor et Jardin
Parc Industriel - Rue Nazareth, 13
4651 Battice - Belgique
e-mail : info@decoretjardin.com
website : www.decoretjardin.com

