

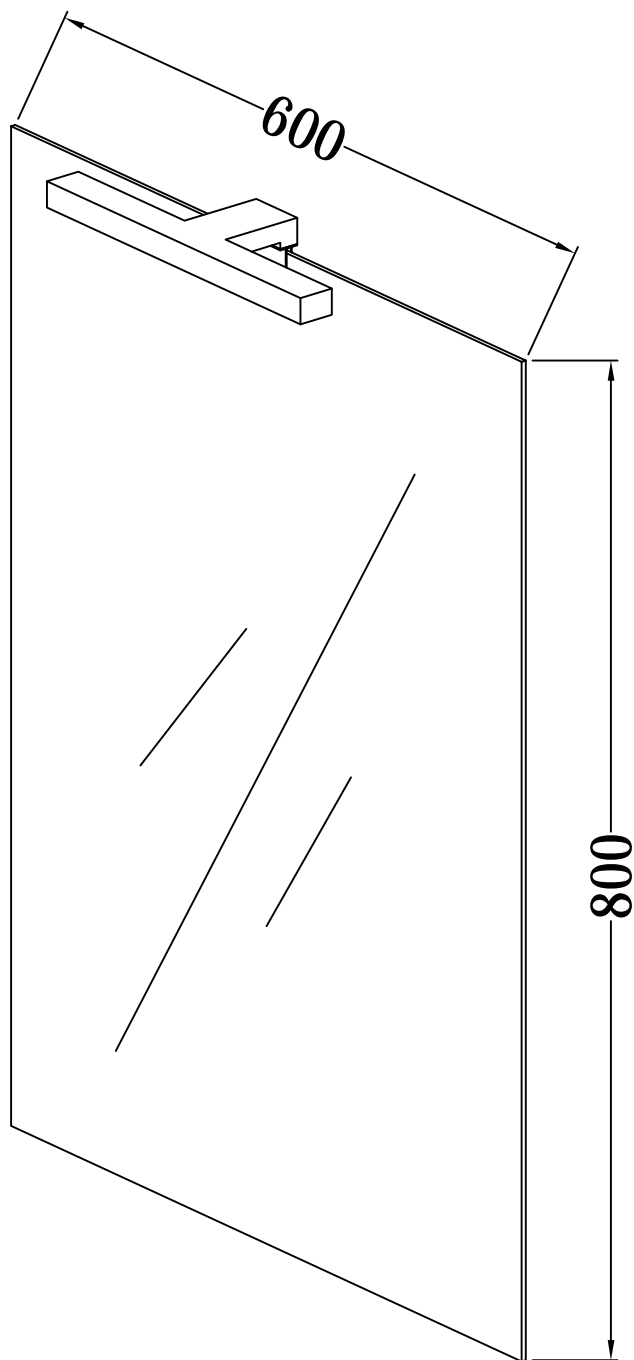

# LAV 692

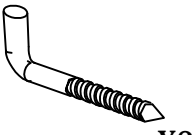

[www.aurlane.fr](http://www.aurlane.fr)

<p><b>XGG</b></p>  <p>X2</p>	<p><b>XPZ 6*30</b></p>  <p>X2</p>	<p><b>AURL1637</b></p>  <p>X1</p>
---	--	---

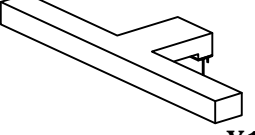
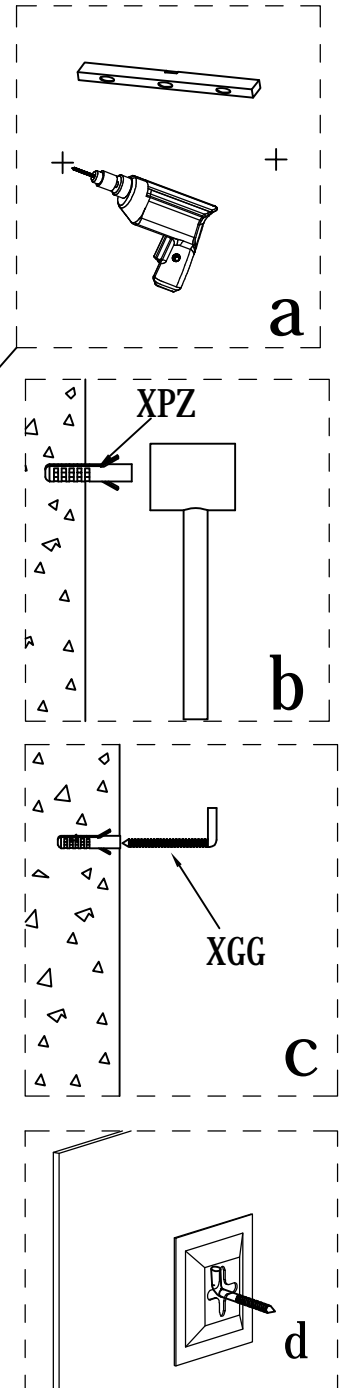
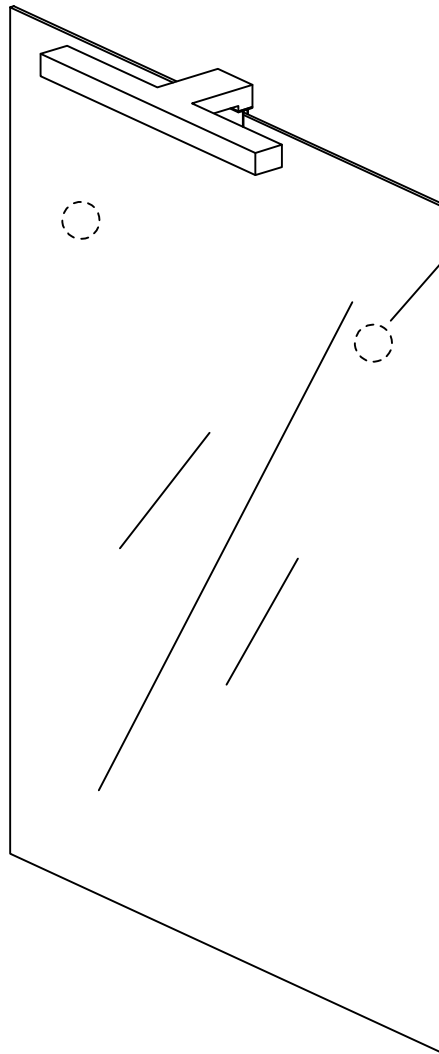
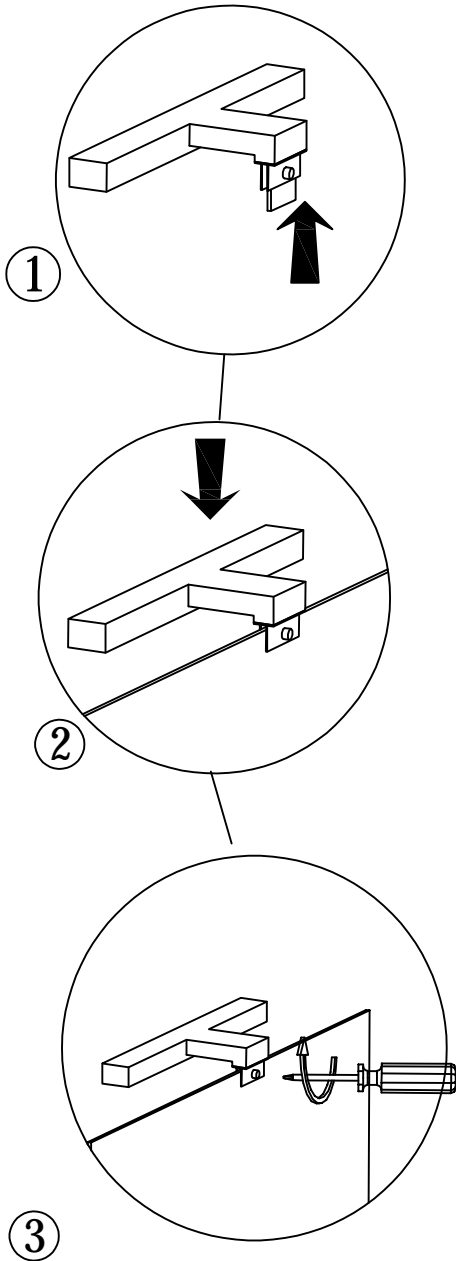

### INSTALLATION DU LUMINAIRE

- 1- Ne pas oublier le joint plastique de protection du verre
- 2- Insérer l'applique sur le verre
- 3- Ne pas visser trop fort